

Neosys Technology Inc.

POC-700 Series

POC-700-FT Series

User Manual

Revision 1.2

Table of Contents

Table of Contents	2
Legal Information	4
Contact Information	5
Declaration of Conformity	5
Copyright Notice	6
Safety Precautions	7
Service and Maintenance	8
ESD Precautions	8
About This Manual	9
1 Introduction	
1.1 Specification of POC-715/ POC-715-FT	11
1.2 Specification of POC-712/ POC-712-FT	13
1.3 Dimension of POC-700	15
1.3.1 POC-700 Front Panel View.....	15
1.3.2 POC-700 Reserved Panel View.....	16
1.3.3 POC-700 COM Port Panel View	16
1.3.4 POC-700 Bottom View.....	17
1.4 Dimensions of POC-700-FT	18
1.4.1 POC-700-FT Front Panel View	18
1.4.2 POC-700-FT Reserved Panel View	19
1.4.3 POC-700-FT COM Port Panel View.....	19
1.4.4 POC-700-FT Bottom View	20
2 System Overview	
2.1 Unpacking the System	21
2.2 POC-700 Series Front Panel	22
2.2.1 System Status LED.....	23
2.2.2 HDMI.....	24
2.2.3 DisplayPort.....	25
2.2.4 Reset Button	26
2.2.5 USB3.2 Gen2x1 Port	26
2.2.6 IEEE 802.3at Power over Ethernet Port.....	27
2.2.7 3-pin Terminal Block for DC Input (Optional Ignition Input)	28
2.2.8 3-pin Remote On/ Off.....	29
2.3 DIO/ COM Port Panel	30
2.3.1 Digital Input/ Output	31
2.3.2 COM 1 Port.....	33
2.3.3 COM Port (COM2/ COM3/ COM4).....	34
2.3.4 Power Button	35
2.3.5 SMA Antenna Opening.....	36
2.4 CMOS Reset Button	37
2.5 Reserved Port Opening Panel	38
2.6 Internal I/O	39
2.6.1 Full-size mini-PCIe Slot and SIM Socket	39
2.6.2 M.2 2280 (M Key) Slot for SSD.....	41
2.6.3 SO-DIMM Socket	43
2.7 MeziO® Interface	44
2.7.1 MeziO® Interface Pin Definition.....	45
2.7.2 MeziO® Modules for POC-700 Series.....	46
3 System Installation	
3.1 Disassembling the System Enclosure	48
3.1.1 Disassembling POC-700.....	48
3.1.2 Disassembling POC-700-FT	51

3.2	Installing Internal Components	54
3.2.1	DDR5 SO-DIMM Installation	54
3.2.2	M.2 2880 M Key SSD Installation	56
3.2.3	mini-PCIe Module, SIM Card and Antenna Installation	58
3.2.4	MezIO® Module Installation	62
3.3	Installing the System Enclosure	65
3.3.1	Installing POC-700's Enclosure	65
3.3.2	Installing POC-700-FT's Enclosure	67
3.4	POC-700 DIN Rail Installation	70
3.5	POC-700 Horizontal Wall Mount Installation (Optional)	73
3.5.1	POC-700 Vertical Wall Mount Bracket (Optional)	75
3.6	Mounting POC-700-FT	76
3.6.1	Mounting POC-700-FT	76
3.6.2	Mounting POC-700-FT Using Brackets	77
3.7	Fan Kit Installation (Optional)	79
3.8	Powering On the System	81
3.8.1	Powering On Using the Power Button	81
3.8.2	Powering On Using An External Non-Latched Switch	82
3.8.3	Powering On Using Wake-on-LAN	83

4 BIOS Settings

4.1	COM1 Port Configuration	87
4.2	COM 2/ 3/ 4 Port Configuration	88
4.3	COM Port High Speed Mode	89
4.4	TPM Availability	90
4.5	Power over Ethernet (PoE)	91
4.6	Wake-on-LAN	92
4.7	C-States	93
4.8	Power On after Power Failure	95
4.9	Boot Menu	96
4.10	Position New Boot Device	98
4.11	Watchdog Timer	99

5 OS Support and Driver Installation

5.1	Operating System Compatibility	100
5.2	Driver Installation	101
5.3	Driver Installation for Watchdog Time Control	101

Appendix A Using WDT & DIO

WDT and DIO Library Installation	103
WDT Function Reference	105
InitWDT	105
SetWDT	105
StartWDT	106
ResetWDT	106
StopWDT	106
DIO Functions	107
InitDIO	107
DIReadLine	107
DIReadPort	107
DOWriteLine	108
DOWritePort	108

Appendix B PoE On/ Off Control

PoE On/ Off Control Function Reference	109
GetStatusPoEPort	109
EnablePoEPort	110
DisablePoEPort	111

Legal Information

All Neosys Technology Inc. products shall be subject to the latest Standard Warranty Policy

Neosys Technology Inc. may modify, update or upgrade the software, firmware or any accompanying user documentation without any prior notice. Neosys Technology Inc. will provide access to these new software, firmware or documentation releases from download sections of our website or through our service partners.

Before installing any software, applications or components provided by a third party, customer should ensure that they are compatible and interoperable with Neosys Technology Inc. product by checking in advance with Neosys Technology Inc.. Customer is solely responsible for ensuring the compatibility and interoperability of the third party's products. Customer is further solely responsible for ensuring its systems, software, and data are adequately backed up as a precaution against possible failures, alternation, or loss.

For questions in regards to hardware/ software compatibility, customers should contact Neosys Technology Inc. sales representative or technical support.

To the extent permitted by applicable laws, Neosys Technology Inc. shall NOT be responsible for any interoperability or compatibility issues that may arise when (1) products, software, or options not certified and supported; (2) configurations not certified and supported are used; (3) parts intended for one system is installed in another system of different make or model.

Contact Information

Headquarters
(Taipei, Taiwan) **Neosys Technology Inc.**
15F, No.868-3, Zhongzheng Rd., Zhonghe Dist., New Taipei City, 23586, Taiwan
Tel: +886-2-2223-6182 Fax: +886-2-2223-6183 [Email](#), [Website](#)

Americas
(Illinois, USA) **Neosys Technology America Inc.**
3384 Commercial Avenue, Northbrook, IL 60062, USA
Tel: +1-847-656-3298 [Email](#), [Website](#)

China **Neosys Technology China Co., Ltd.**
Room 612, Building 32, Guiping Road 680, Shanghai
Tel: +86-2161155366 [Email](#), [Website](#)

Declaration of Conformity

FCC This equipment has been tested and found to comply with the limits for a Class A digital device, pursuant to part 15 of the FCC Rules. These limits are designed to provide reasonable protection against harmful interference when the equipment is operated in a commercial environment. This equipment generates, uses, and can radiate radio frequency energy and, if not installed and used in accordance with the instruction manual, may cause harmful interference to radio communications. Operation of this equipment in a residential area is likely to cause harmful interference in which case the user will be required to correct the interference at own expense.

CE The product(s) described in this manual complies with all applicable European Union (CE) directives if it has a CE marking. For computer systems to remain CE compliant, only CE-compliant parts may be used. Maintaining CE compliance also requires proper cable and cabling techniques.

Copyright Notice

All rights reserved. This publication may not be reproduced, transmitted, transcribed, stored in a retrieval system, or translated into any language or computer language, in any form or by any means, electronic, mechanical, magnetic, optical, chemical, manual or otherwise, without the prior written consent of Neosys Technology, Inc.

Disclaimer

This manual is intended to be used as an informative guide only and is subject to change without prior notice. It does not represent commitment from Neosys Technology Inc. Neosys Technology Inc. shall not be liable for any direct, indirect, special, incidental, or consequential damages arising from the use of the product or documentation, nor for any infringement on third party rights.

Patents and Trademarks

Neosys, the Neosys logo, Expansion Cassette, MezIO™ are registered patents and trademarks of Neosys Technology, Inc.

Windows is a registered trademark of Microsoft Corporation.

AMD, Ryzen™ are registered trademarks of Advanced Micro Devices, Inc

All other names, brands, products or services are trademarks or registered trademarks of their respective owners.

Safety Precautions

- Read these instructions carefully before you install, operate, or transport the system.
- Install the system or DIN rail associated with, at a sturdy location
- Install the power socket outlet near the system where it is easily accessible
- Secure each system module(s) using its retaining screws
- Place power cords and other connection cables away from foot traffic. Do not place items over power cords and make sure they do not rest against data cables
- Shutdown, disconnect all cables from the system and ground yourself before touching internal modules
- Ensure that the correct power range is being used before powering the device
- Should a module fail, arrange for a replacement as soon as possible to minimize down-time
- If the system is not going to be used for a long time, disconnect it from mains (power socket) to avoid transient over-voltage

Service and Maintenance

- ONLY qualified personnel should service the system
- Shutdown the system, disconnect the power cord and all other connections before servicing the system
- When replacing/ installing additional components (expansion card, memory module, etc.), insert them as gently as possible while assuring proper connector engagement

ESD Precautions

- Handle add-on module, motherboard by their retention screws or the module's frame/ heat sink. Avoid touching the PCB circuit board or add-on module connector pins
- Use a grounded wrist strap and an anti-static work pad to discharge static electricity when installing or maintaining the system
- Avoid dust, debris, carpets, plastic, vinyl and styrofoam in your work area.
- Do not remove any module or component from its anti-static bag before installation

About This Manual

This manual introduces and demonstrates installation procedures of Neosys POC-700 series systems featuring an Intel® Core™ i3-N305 or Atom® x7425e processor. The manual also demonstrates the system's general installation procedures.

Revision History

Version	Date	Description
1.0	Oct. 2023	Initial release
1.1	Apr. 2024	Updated specifications
1.2	Sep. 2024	Added POC-700-FT series

1 Introduction

POC-700/ POC-700-FT series is Neosys' next-generation ultra-compact embedded controller, with a choice of the latest Intel Alder Lake i3-N305 or x7425E processor that delivers up to 1.3x the CPU performance over previous POC-500 series.



POC-700 series



POC-700-FT series

Neosys POC-700/ POC-700-FT is powered by Intel's Alder Lake i3-N305 featuring 8-core/ 8-thread processor with 32EUs UHD Graphics or Atom® x7425E featuring 4-core/ 4-thread with 24EUs UHD Graphics to support Intel OpenVINO™ for AI inference capabilities. The system adopts DDR5-4800 to offer up to 1.8x the memory bandwidth over DDR4 to boost overall system performance. It also has four USB3.2 Gen2, and four GigE PoE+ ports with screw lock mechanisms to connect and secure industrial cameras for machine vision applications. Display output wise, there are HDMI and DP video outputs to support high-definition display devices. As for connections and expansions, POC-700 features isolated DIO for device monitoring/control, M.2 2280 M key for SATA SSD and a mini-PCIe socket for wireless WiFi, LTE/5G or CAN bus device.

Measuring just 64 x 116 x 176mm, the ultra-compact POC-700 can easily fit into confined spaces and is a seamless upgrade from POC-500 series with identical footprint. The flat heatsink design of POC-700-FT series measures approximately 52 x 116 x 176 mm, reducing the overall size up to 30%, allowing it to fit into more compact spaces. This design integrates an even smaller form factor, making it suitable for deployment in more challenging environments, such as those requiring dust and water resistance.

Benefiting from the performance gains of the latest Intel CPU, wide-temperature fanless design, and ample interfaces for industrial cameras and I/Os, POC-700 is perfect for machine vision and smart city applications.

1.1 Specification of POC-715/ POC-715-FT

System Core	
Processor	Intel® Alder Lake Core™ i3-N305 processor (8C/8T, 1.8/3.8 GHz, 15W TDP)
Graphics	Integrated Intel® HD Graphics with 32EUs
Memory	Up to 16 GB DDR5-4800 SDRAM (one SODIMM socket)
TPM	Supports dTPM 2.0
Panel I/O Interface	
Ethernet	4x Gb Ethernet ports by Intel® I350-AM4
PoE+	IEEE 802.3at PoE+ on port #1~ 4
Native Video Port	1x DP++, Supporting 4096 x 2160 resolution @ 60Hz 1x HDMI1.4b, Supporting 3840 x 2160 @ 30Hz
Serial Port	1x Software-programmable RS-232/422/485 ports (COM1) 3x 3-wire RS-232 ports (COM2/3/4) or 1x RS-422/485 port (COM2)
USB	4x USB 3.2 Gen2 ports with screw-lock
Isolated DIO	4-CH isolated DI and 4-CH isolated DO
Internal I/O Expansion Interface	
Mini PCI-E	1x full-size mini PCI Express socket with internal SIM socket
Expandable I/O	1x MezIO® expansion interface for Neousys MezIO® modules
Storage Interface	
M.2	1x M.2 2280 M key socket (PCIe Gen3 x1) for NVMe SSD storage (supports SATA signal)
Power Supply	
DC input	1x 3-pin pluggable terminal block for 8V to 35V DC input 1x 3-pin pluggable terminal block for 12V to 35V DC input (UL series)
Remote Ctrl.& LED output	1x3-pin pluggable terminal block for remote control and PWR LED output
Mechanical	
Dimension	POC-715: 64.4 mm x 116 mm x 176 mm POC-715-FT: 51.65 mm x 115.5mm x 175.8 mm
Weight	1.2kg
Mounting	DIN-rail mount (standard) or wall-mount (optional)
Fan kit	Optional external-accessible fan kit 80mm x 80mm

Environmental	
Operating temperature	-25°C to 70°C*
Storage temperature	-40°C to 85°C
Humidity	10% to 90% , non-condensing
Vibration	MIL-STD-810H, Method 514.8, Category 4
Shock	MIL-STD-810H, Method 516.8, Procedure I
EMC	CE/ FCC Class A, according to EN 55032 & EN 55035
Safety	UL 62368-1, IEC 62368-1 (UL series only)

** For sub-zero and over 60°C operating temperature, a wide temperature Solid State Disk (SSD) is required.*

1.2 Specification of POC-712/ POC-712-FT

System Core	
Processor	Intel® Atom® x7425E
Graphics	Integrated Intel® HD Graphics 24EUs
Memory	Up to 16 GB DDR5-4800 SDRAM (one SODIMM socket)
TPM	Supports dTPM 2.0
Panel I/O Interface	
Ethernet	4x Gb Ethernet ports by Intel® I350-AM4
Native Video Port	1x DP++, Supporting 4096 x 2160 resolution @60Hz 1x HDMI1.4b, Supporting 3840 x 2160 @ 30Hz
Serial Port	1x Software-programmable RS-232/422/485 ports (COM1) 3x 3-wire RS-232 ports (COM2/3/4) or 1x RS-422/485 port (COM2)
USB	4x USB 3.2 Gen2 ports with screw-lock
Isolated DIO	4-CH isolated DI and 4-CH isolated DO
Internal I/O Expansion Interface	
Mini PCI-E	1x full-size mini PCI Express socket with internal SIM socket
Expandable I/O	1x MezIO® expansion interface for Neousys MezIO® modules
Storage Interface	
M.2	1x M.2 2280 M key socket (PCIe Gen3 x1) for NVMe SSD storage (supports SATA signal)
Power Supply	
DC input	1x 3-pin pluggable terminal block for 8V to 35V DC input 1x 3-pin pluggable terminal block for 12V to 35V DC input (UL series)
Remote Ctrl.& LED output	1x3-pin pluggable terminal block for remote control and PWR LED output
Mechanical	
Dimension	POC-712: 64.4 mm x 116 mm x 176 mm POC-712-FT: 51.65 mm x 115.5mm x 175.8 mm
Weight	1.2kg
Mounting	DIN-rail mount (standard) or wall-mount (optional)
Fan kit	Optional external-accessible fan kit 80mm x 80mm
Environmental	
Operating temperature	-25°C to 70°C*

Storage temperature	-40°C to 85°C
Humidity	10% to 90% , non-condensing
Vibration	MIL-STD-810H, Method 514.8, Category 4
Shock	MIL-STD-810H, Method 516.8, Procedure I
EMC	CE/ FCC Class A, according to EN 55032 & EN 55035
Safety	UL 62368-1, IEC 62368-1 (UL series only)

** For sub-zero and over 60°C operating temperature, a wide temperature Solid State Disk (SSD) is required.*

1.3 Dimension of POC-700

 **NOTE**
All measurements are in millimeters (mm).

1.3.1 POC-700 Front Panel View

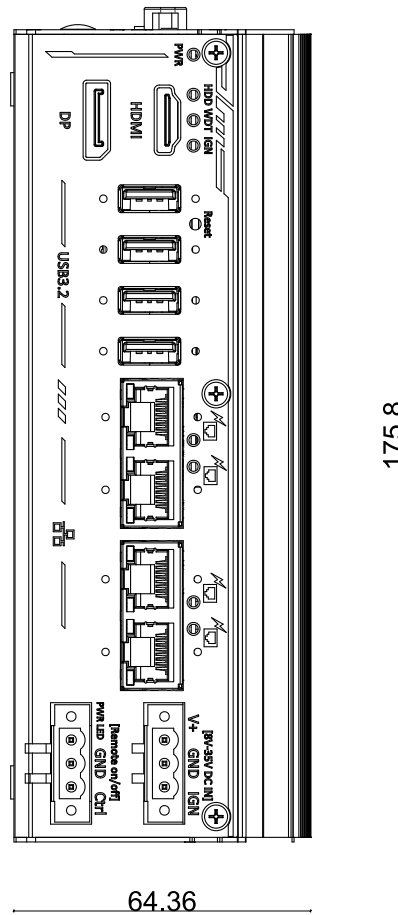

1.3.2 POC-700 Reserved Panel View

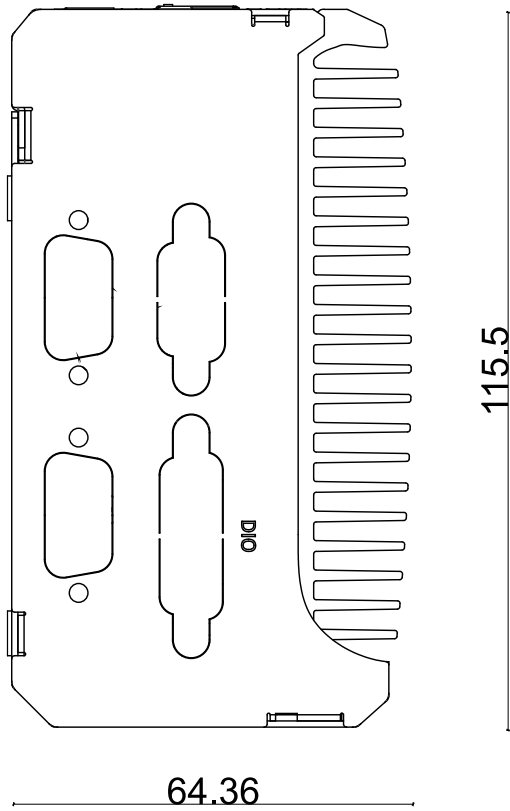

1.3.3 POC-700 COM Port Panel View

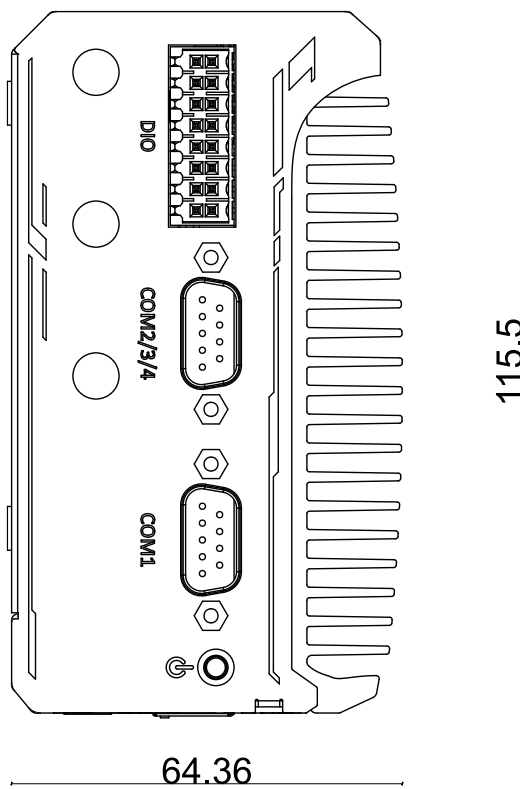

1.3.4 POC-700 Bottom View

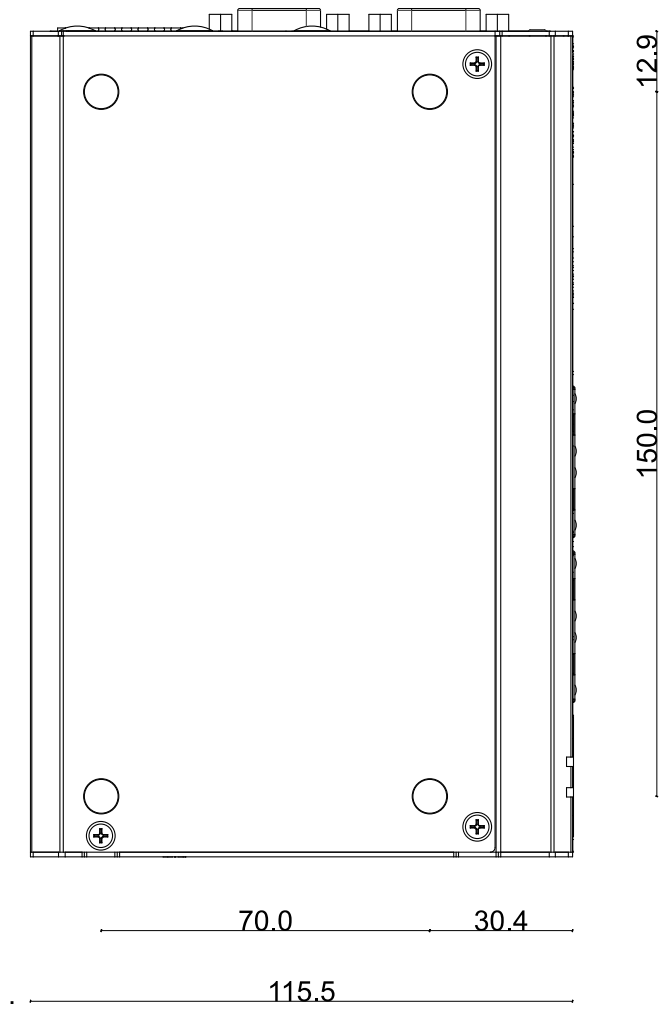

1.4 Dimensions of POC-700-FT

 NOTE

All measurements are in millimeters (mm).

1.4.1 POC-700-FT Front Panel View

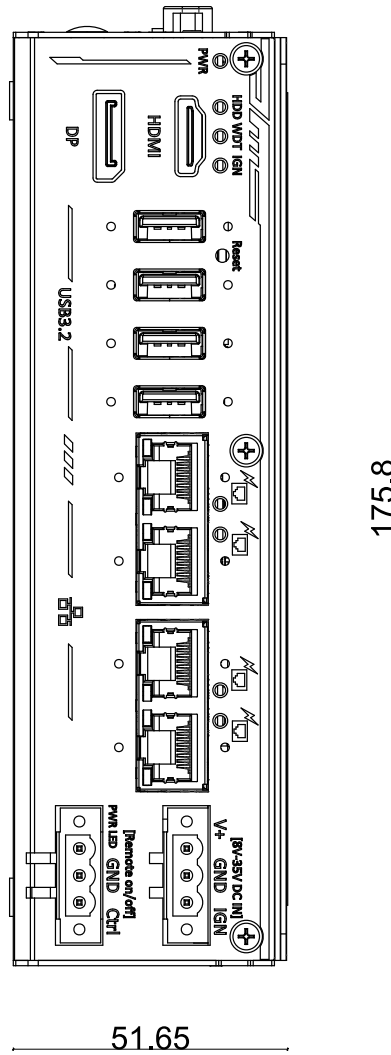

1.4.2 POC-700-FT Reserved Panel View

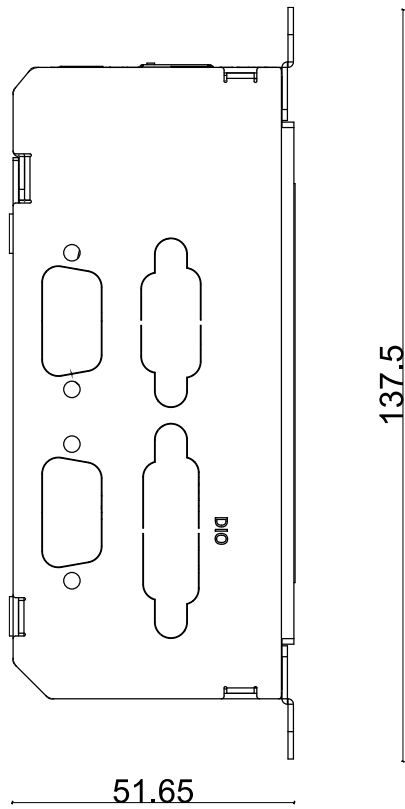

1.4.3 POC-700-FT COM Port Panel View

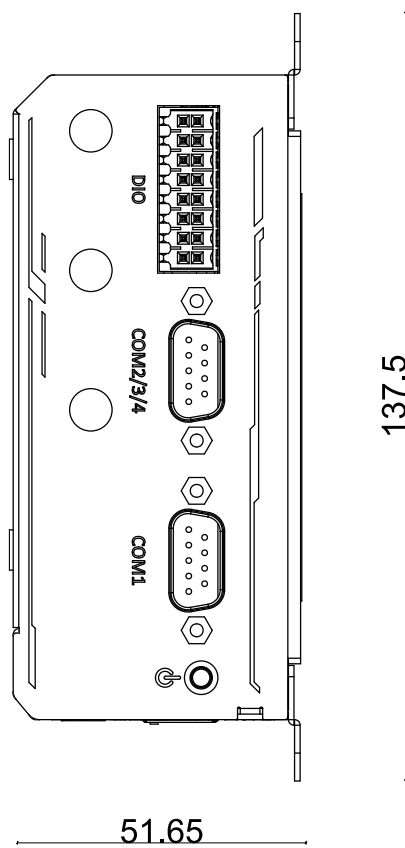

1.4.4 POC-700-FT Bottom View

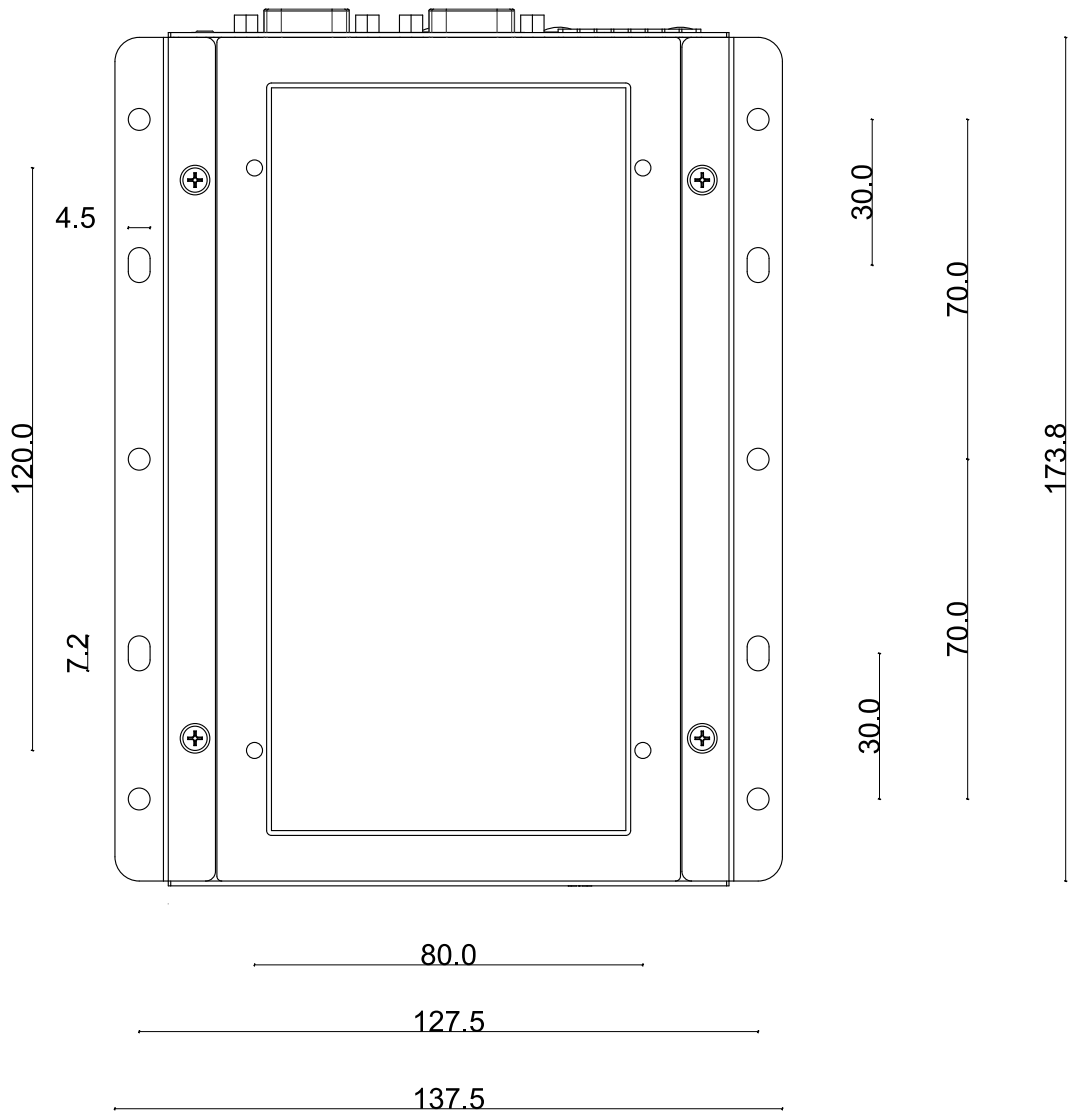

2 System Overview

Upon receiving and unpacking your POC-700 systems, please check immediately if the package contains all the items listed in the following table. If any item(s) are missing or damaged, please contact your local dealer or Neosys Technology.

2.1 Unpacking the System

Item	Description	Qty
1	POC-700 (Please verify ordered items such as CPU, RAM, HDD, etc.)	1
2	Accessory box, which contains <ul style="list-style-type: none">● DIN-Rail Mount Clip● 3-pin power terminal block● 16-pin DIO terminal block● Screw pack	1 2 1 1

2.2 POC-700 Series Front Panel

NOTE
The POC-700 and POC-700-FT share the same I/O ports, therefore POC-700 will be shown here for demonstration purposes.

The front panel of POC-700/ POC-700-FT series features four PoE+ Gigabit Ethernet ports, four USB 3.1 Gen1 ports, one DisplayPort, one HDMI port, remote control and 3-pin terminal block for DC input.

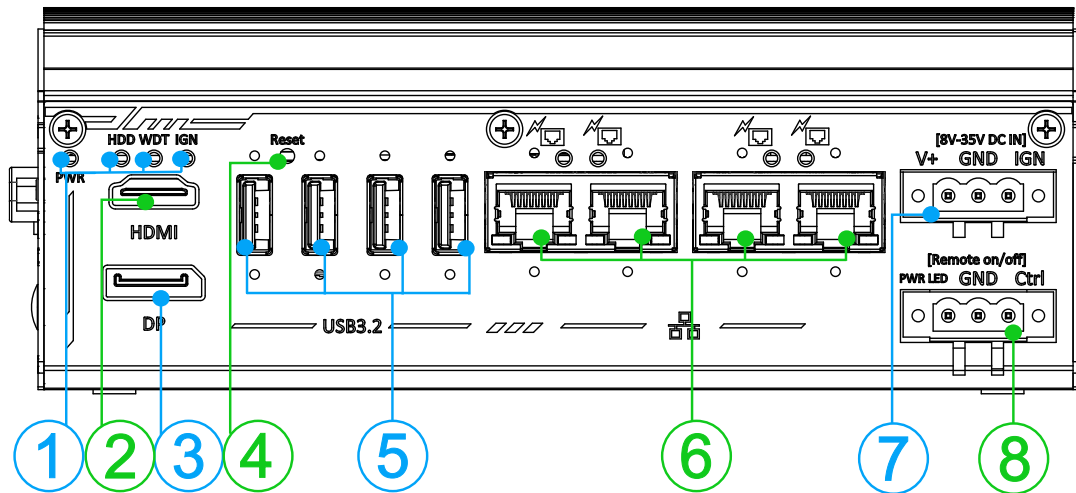

No.	Item	Description
1	System status LED	System LEDs, Hard Disk Drive (HDD), Watchdog Timer (WDT), Ignition control (IGN).
2	HDMI	The HDMI port is a high-resolution graphics/ data port supporting up to 3840 x 2160 @ 30Hz.
3	DisplayPort output	The DisplayPort is a high-resolution graphics output supporting up to 4096 x 2160 @ 60Hz.
4	Reset button	Use this button to manually reset the system.
5	USB3.2 Gen2x1 port	USB3.2 Gen 2 port (SuperSpeed+) offers up to 10Gbps. It is also backwards compatible with USB3.0 and USB2.0
6	Ethernet & PoE+	4x Gb Ethernet ports by Intel® I350-AM4 with Power over Ethernet port (on POC-715 only) that can provide both data and electric power to devices.
7	3-pin DC terminal block (optional ignition input)	Compatible with DC power input from 8V - 35V (12V - 35V for UL series). When MezIO™-V20 module is installed, it can also be used for ignition signal input.
8	3-pin Remote on/ off control	Allows for external switch extension when the system is placed inside a cabinet.

2.2.1 System Status LED

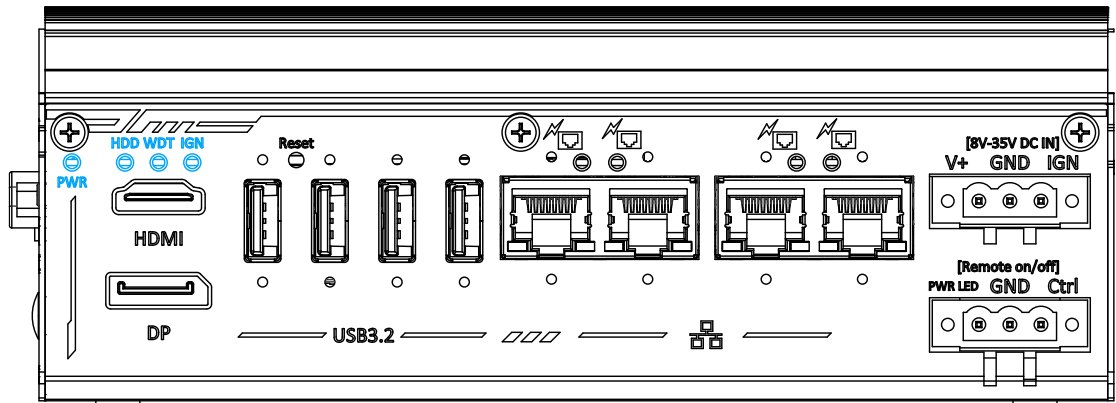

There are three LED indicators on the front panel: HDD, WDT and IGN. The descriptions of these LEDs are listed in the following table.

Indicator	Color	Description
PWR	Green	Power indicator, lit when system is on.
HDD	Red	Hard drive indicator, flashing when SATA HDD is active
WDT	Yellow	Watchdog timer indicator, flashing when watchdog timer has started
IGN	Yellow	Ignition power control, lit when IGN signal is applied.

2.2.2 HDMI

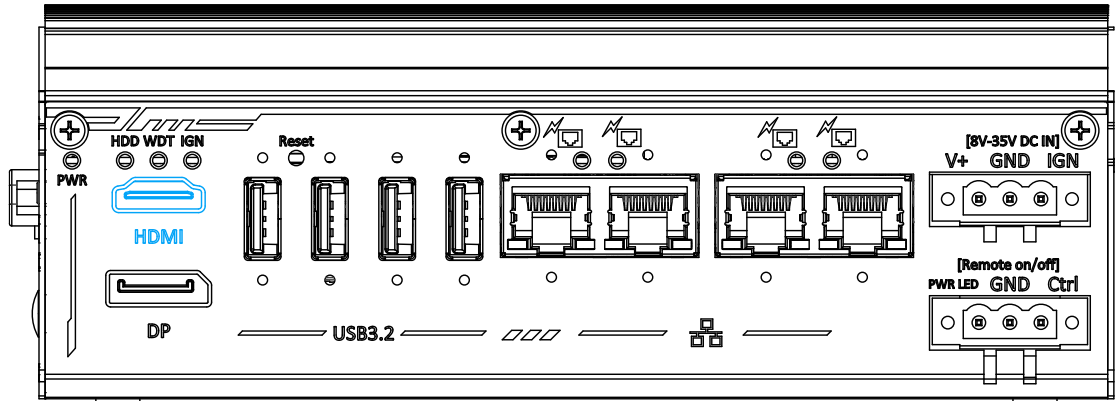

The High-Definition Multimedia Interface (HDMI) port provides uncompressed high-quality digital video and audio transmission between the system and a multimedia display device on a single cable. You can connect to other digital inputs by using a HDMI-to-DVI or HDMI-to-DP cable.



HDMI-to-DP

The system supports dual independent display outputs by connecting display devices to HDMI and DisplayPort connection. To support dual display outputs and achieve best DisplayPort output resolution in Windows, you need to install corresponding graphics drivers. Please refer to section [OS Support and Driver Installation](#) for details.

2.2.3 DisplayPort

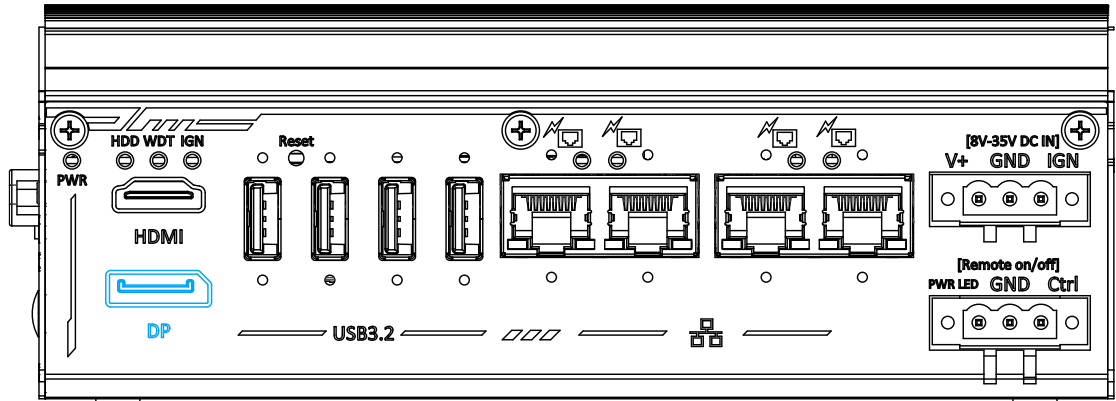

The system has a DisplayPort (DP) output which is a digital display interface that mainly connect video source and carry audio to a display device. When connecting a DP, it can deliver up to 4K UHD (4096 x 2160 @ 60Hz) in resolution. The system is designed to support passive DP adapter/ cable. You can connect to other display devices using DP-to-HDMI cable or DP-to-DVI cable.



DP-to-HDMI



DP-to-DVI

The system supports dual independent display outputs by connecting display devices to HDMI and DisplayPort connection. To support dual display outputs and achieve best DisplayPort output resolution in Windows, you need to install corresponding graphics drivers. Please refer to section [OS Support and Driver Installation](#) for details.

2.2.4 Reset Button

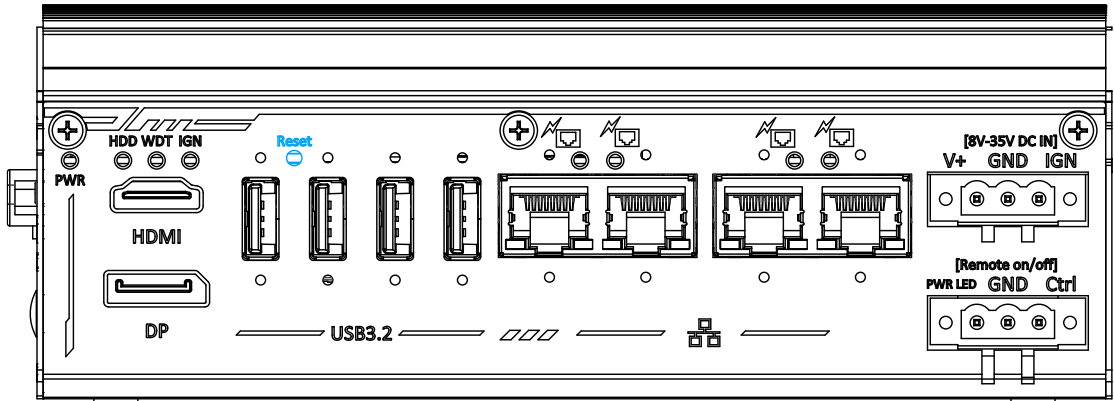

The reset button is used to manually reset the system in case of system halt or malfunction. To avoid unexpected reset, the button is purposely placed behind the panel. To reset, please use a pin-like object (eg. tip of a pen) to access the reset button

2.2.5 USB3.2 Gen2x1 Port

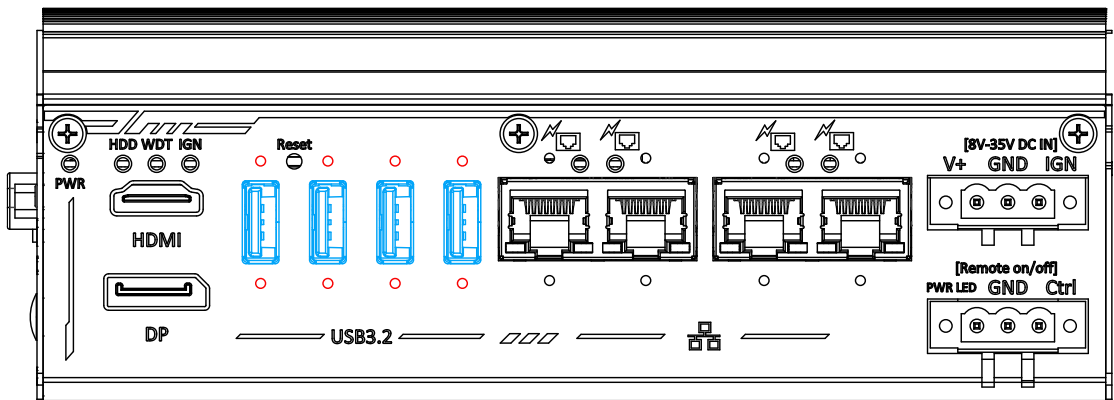

The system's USB 3.2 Gen2x1 ports (10Gbps) are implemented via native xHCI (eXtensible Host Controller Interface) controller and are backward compatible with USB3.2 Gen.1 USB 2.0, USB 1.1 and USB 1.0 devices. UEFI USB is also supported so you can use USB keyboard/ mouse in UEFI shell environment. Indicated in **red** are screw-lock holes for the corresponding USB port.

xHCI driver is supported natively in Windows 10, therefore you do not need to install the xHCI driver prior to utilizing USB functions.

2.2.6 IEEE 802.3at Power over Ethernet Port

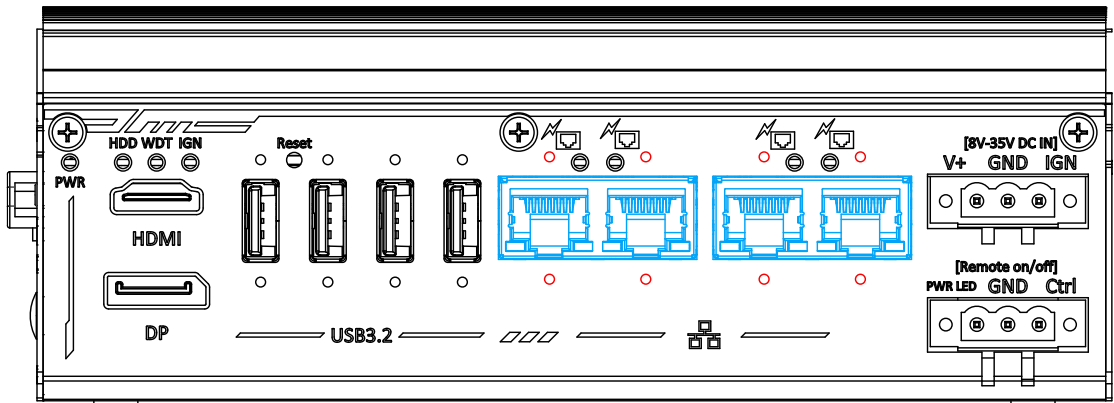

The system offers four Gb Ethernet ports via Intel® I350-AM4 and is backward compatible with 100/ 10Mb connection speeds.

The Gigabit Power over Ethernet (PoE) port is only available on POC-715 system that can supply power and data on a standard CAT-5/CAT-6 Ethernet cable. Acting as a PSE (Power Sourcing Equipment), compliant with IEEE 802.3at, each port delivers up to 25W to a Powered Device (PD). PoE automatically detects and determine if the connected device is PoE PD or not before supplying power, making it compatible with standard Ethernet devices as well. Indicated in **red** is a screw-lock hole for the corresponding Ethernet port.

Active/Link LED (Right)

LED Color	Status	Description
Green	Off	Ethernet port is disconnected
	On	Ethernet port is connected and no data transmission
	Flashing	Ethernet port is connected and data is transmitting/receiving

Speed LED (Left)

LED Color	Status	Description
Green or Orange	Off	10 Mbps
	Green	100 Mbps
	Orange	1000 Mbps

2.2.7 3-pin Terminal Block for DC Input (Optional Ignition Input)

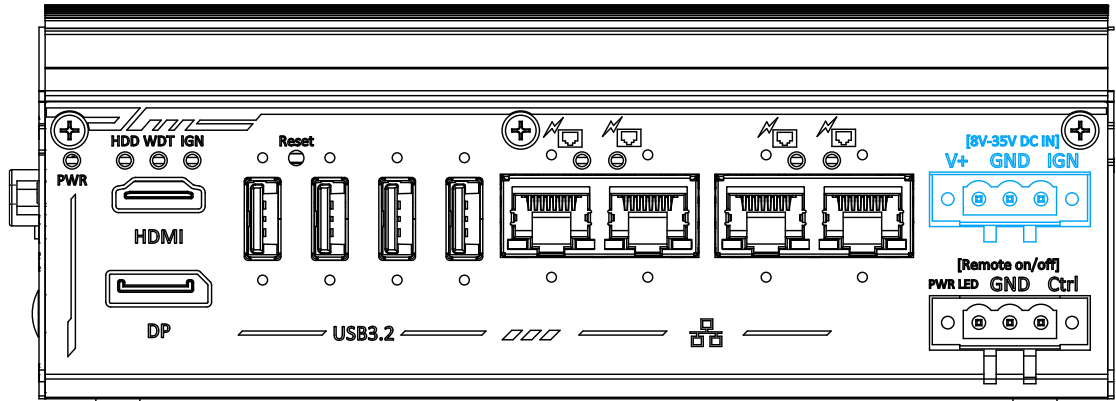

The system accepts a wide range of DC power input from 8V to 35V or 12V to 35V (UL series) via a 3-pin pluggable terminal block, which is fit for field usage where DC power is usually provided. The screw clamping mechanism on the terminal block offers connection reliability when wiring DC power.

In addition to DC power input, this terminal block can also accept an optional ignition signal input (IGN) when you have MezIO™ module with IGN function installed.



WARNING

Please make sure the voltage of DC power is correct before you connect it to the system. Supplying a voltage over 35V will damage the system.



NOTE

The POC-700 UL series accepts 12V – 35V via a 3-pin pluggable terminal block.

2.2.8 3-pin Remote On/ Off

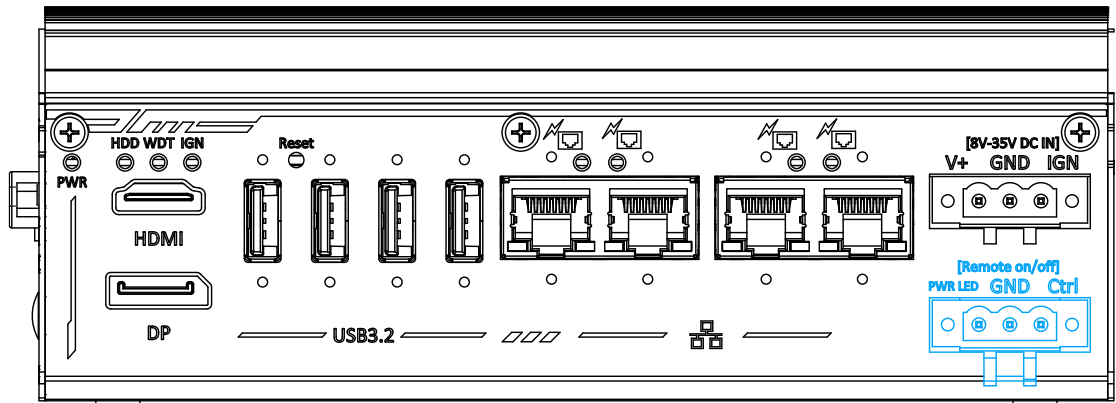

The “Remote On/ Off” 3-pin connection allows for external switch extension. It is useful when the system is placed in a cabinet or a not easily accessed location. You may connect an external remote with an external status LED indicator (15mA) by connecting to PWR LED and GND.

2.3 DIO/ COM Port Panel

The COM port panel of POC-700 series features additional I/O functions, such as digital input/ output, COM ports, and reserved antenna openings for SMA antenna installation. In addition, the power button can also be located on this panel.

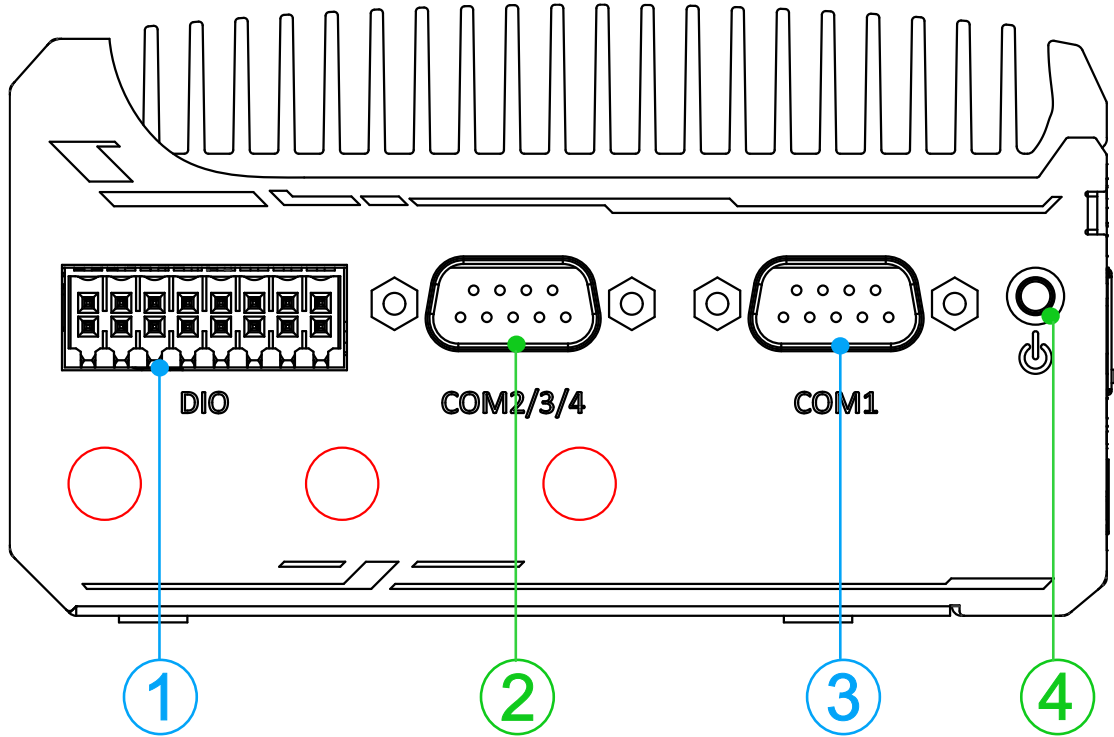

No.	Item	Description
1	Digital I/O	4 channel isolated digital input 4 channel isolated digital output
2	COM port 2/ 3/ 4	Can be configured as: COM2: single RS-422/ 485 port COM2/ COM3/ COM4: three 3-wire RS-232 ports
3	COM port 1	Software programmable RS-232/ 422/ 485 port.
4	Power button	Use this button to turn on or shutdown the system.
		Opening reserved for SMA antenna installation.

2.3.1 Digital Input/ Output

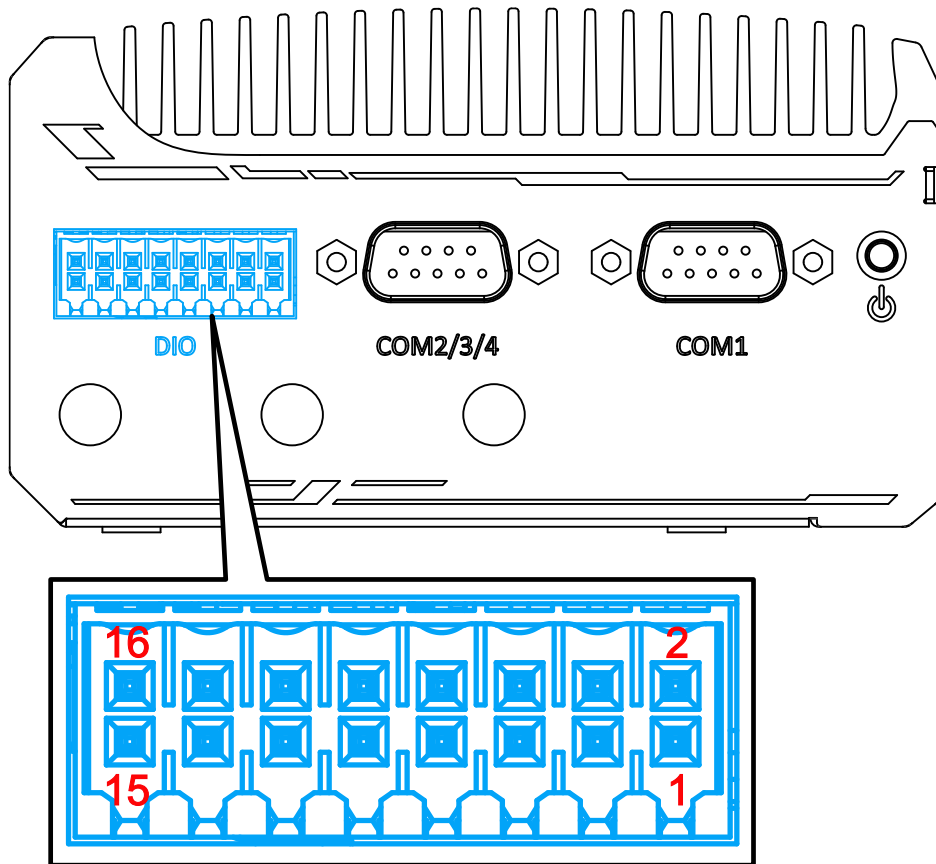

The system provides 4x isolated digital input channels and 4x isolated digital output channels. The DIO functions support polling mode I/O access and DI change-of-state interrupt. Please refer to [Watchdog Timer & Isolated DIO](#) for information on wiring and programming the isolated DIO channels.

Pin#	Pin Definition	Pin#	Pin Definition
1	ISO_DI0_CN	9	ISO_DO0_CN
2	IGND0	10	EOGND
3	ISO_DI1_CN	11	ISO_DO1_CN
4	IGND1	12	EOGND
5	ISO_DI2_CN	13	ISO_DO2_CN
6	IGND2	14	EOGND
7	ISO_DI3_CN	15	ISO_DO3_CN
8	IGND3	16	VDD

*When using DO0 ~ DO3, DOGND is the ground should be used.

Wiring for DIO

The digital input function is implemented using a photo-coupler with an internally series-connected 1kΩ resistor. You need to provide a voltage to specify the logic high/low state. The input voltage for logic high is 5~24V, and the input voltage for logic low is 0~1.5V.

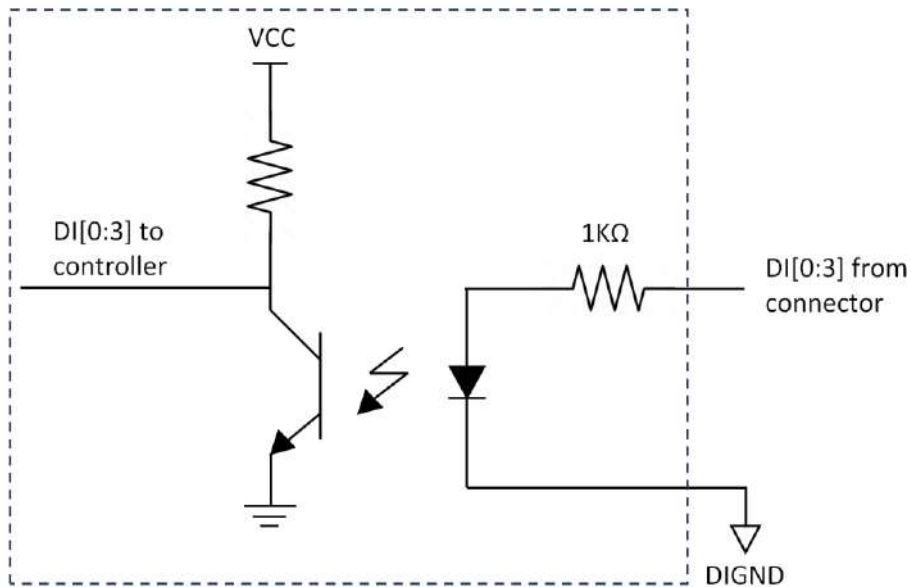

The digital output function is implemented using Power MOSFET + Analog Device iCoupler® component. The DO channels are configured as NO (normally-open) configuration. When you turn on the system, all DO channels have a deterministic state of logic 0 (circuit disconnected from GND return). When logic 1 is specified, MOSFET is activated and GND return path is established. The digital output function on the system supports sinking current connection. The following diagrams are the suggested wiring for DO:

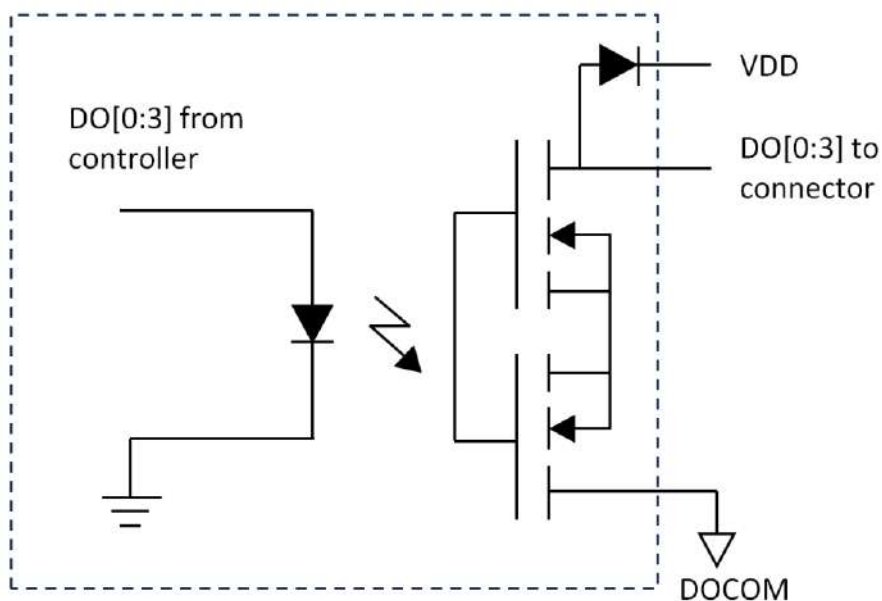

2.3.2 COM 1 Port

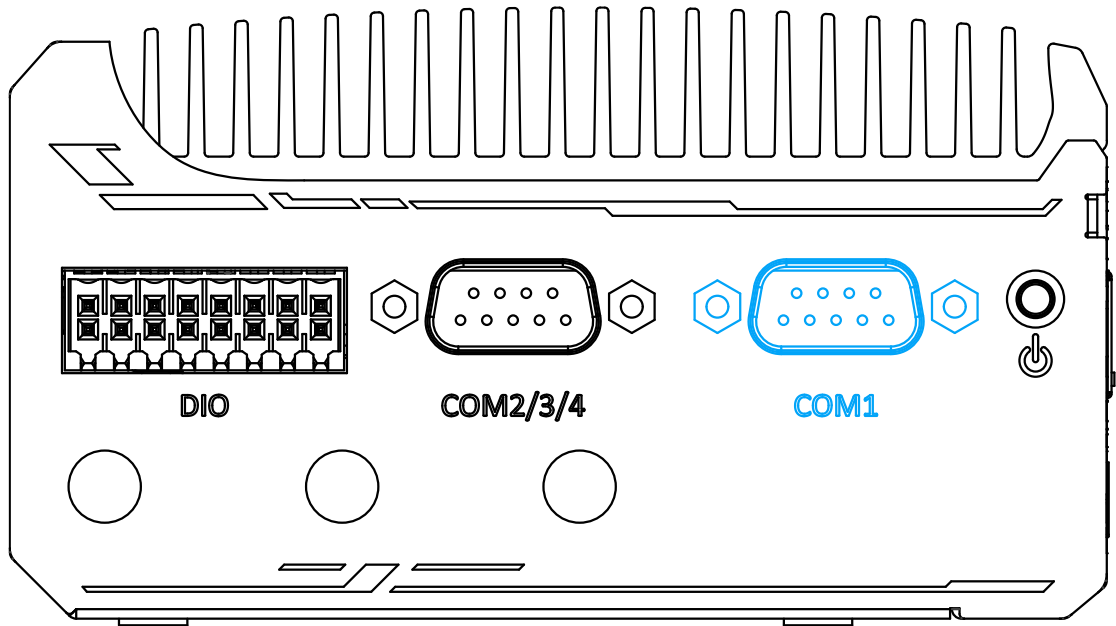

Implemented using industrial-grade ITE8786 Super IO chip (-40 to 85°C) and provide up to 921600 bps baud rate, COM1 is a software-configurable RS-232/422/485 port via 9-pin D-Sub male connector. The operation mode, slew rate and termination of COM1 can be set in BIOS setup utility. The following table describes the pin definition of COM ports.

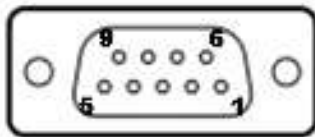

Pin#	COM1		
	RS-232 Mode	RS-422 Mode	RS-485 Mode (Two-wire 485)
1	DCD		
2	RX	422 TXD+	485 TXD+/RXD+
3	TX	422 RXD+	
4	DTR	422 RXD-	
5	GND	GND	GND
6	DSR		
7	RTS		
8	CTS	422 TXD-	485 TXD-/RXD-
9	RI		

2.3.3 COM Port (COM2/ COM3/ COM4)

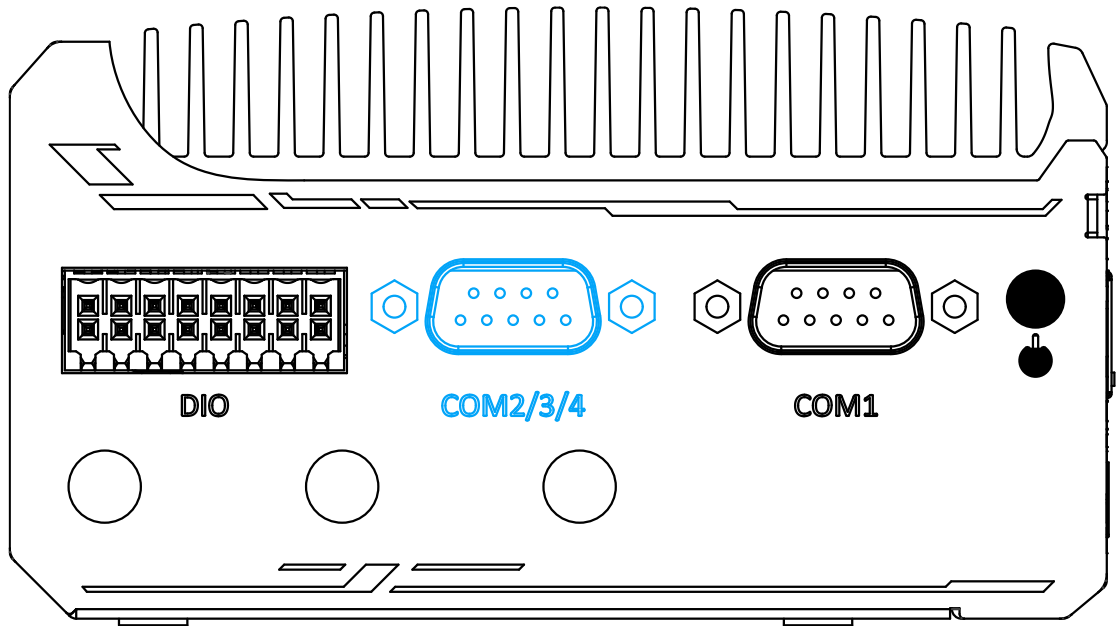

Implemented using industrial-grade ITE8786 Super IO chip (-40 to 85°C) and provide up to 921600 bps baud rate, the D-Sub male connector (COM2/ 3/ 4) can be configured in the BIOS as single RS-422/ 485 port (COM2) or three 3-wire RS-232 ports (COM2/COM3/COM4). Please refer to [COM2/ 3/ 4 Port Configuration](#) for configuring operation mode. An optional 1-to-3 Y-cable is available to connect three RS-232 devices.

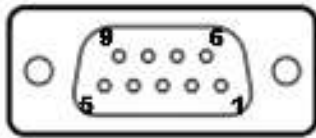

COM2/ 3/ 4 Pin



1-to-3 Y-cable

The following table describes the pin definition of the COM port

Pin#	3-port RS-232 COM2/ 3/ 4		
	COM2	COM3	COM4
1			
2	RX		
3	TX		
4		TX	
5	GND	GND	GND
6		RX	
7			TX
8			RX
9			

Pin#	Single port RS-422/ 485 COM2	
	RS-422	RS-485
1		
2	TxD+	TxD+/ RxD+
3	RxD+	
4	RxD-	
5	GND	GND
6		
7		
8	TxD-	TxD-/ RxD-
9		

2.3.4 Power Button

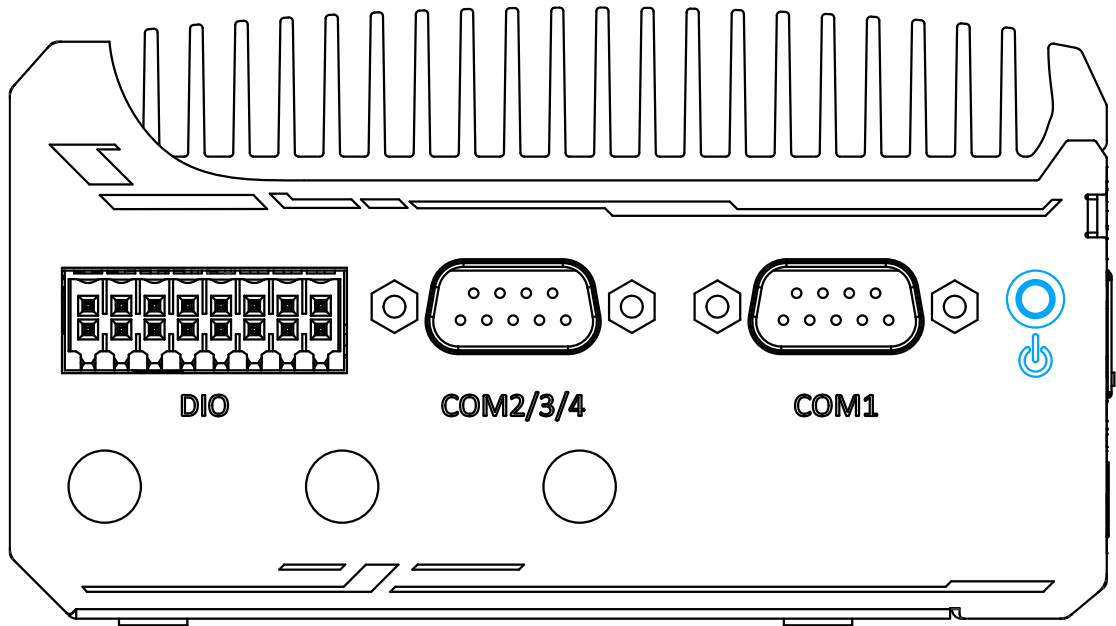

The power button is a non-latched switch for ATX mode on/off operation. Press to turn on the system, PWR LED should light up and to turn off, you can either issue a shutdown command in the OS, or just press the power button. In case of system halts, you can press and hold the power button for 5 seconds to force-shutdown the system. Please note that there is a 5 seconds interval between two on/off operations (i.e. once turning off the system, you will need to wait for 5 seconds to initiate another power-on operation).

2.3.5 SMA Antenna Opening

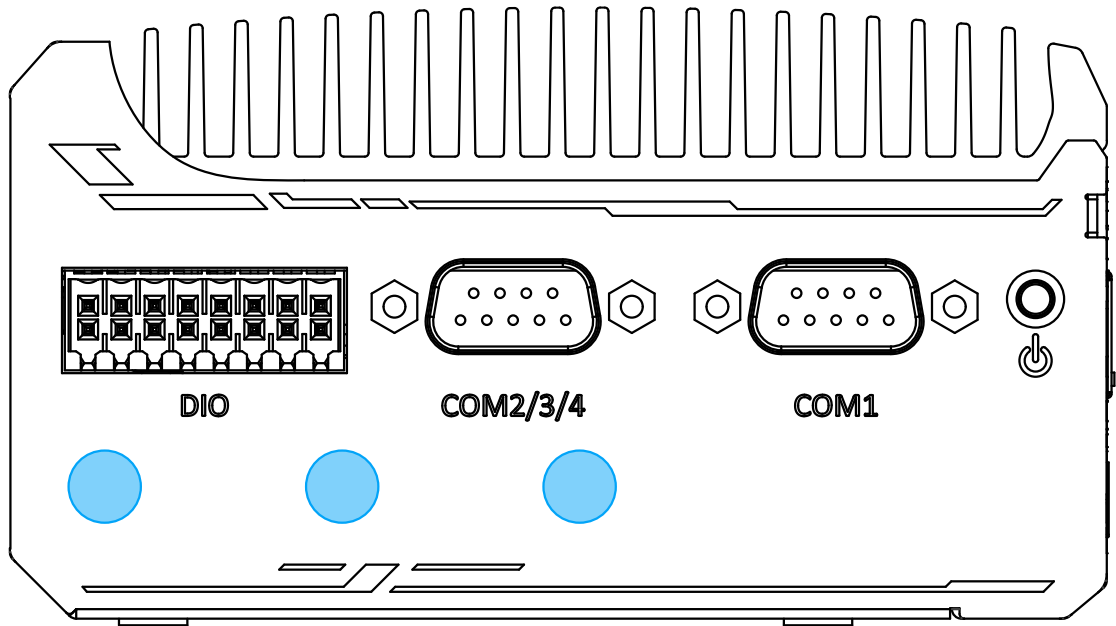

The system offers three SMA antenna openings reserved for SMA antenna installations. Users can take advantage of these three openings when installing mini-PCIe module for wireless communication reception such as 3G, 4G, GPS or WiFi.

2.4 CMOS Reset Button

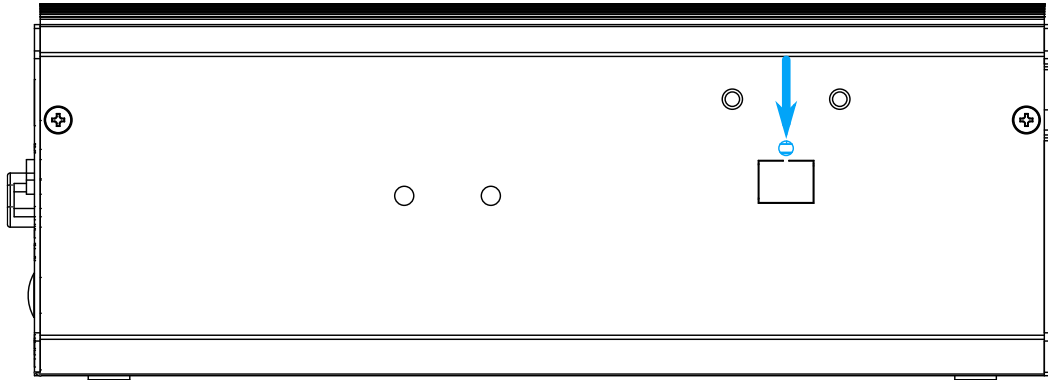

Positioned on the rear panel (opposite the IO panel), indicated by the **blue arrow**, the CMOS Reset button is used to manually reset the motherboard BIOS in case of system halt or malfunction. To avoid unexpected operation, it is purposely placed behind the panel. To reset, please use the tip of a pen, press and hold for at least 5 seconds to reset the BIOS.

2.5 Reserved Port Opening Panel

The reserved port opening panel has reserved openings for DIO or extra COM ports. Choose from a wide range Neosys' MeziO™ modules and find one that best suit your needs.

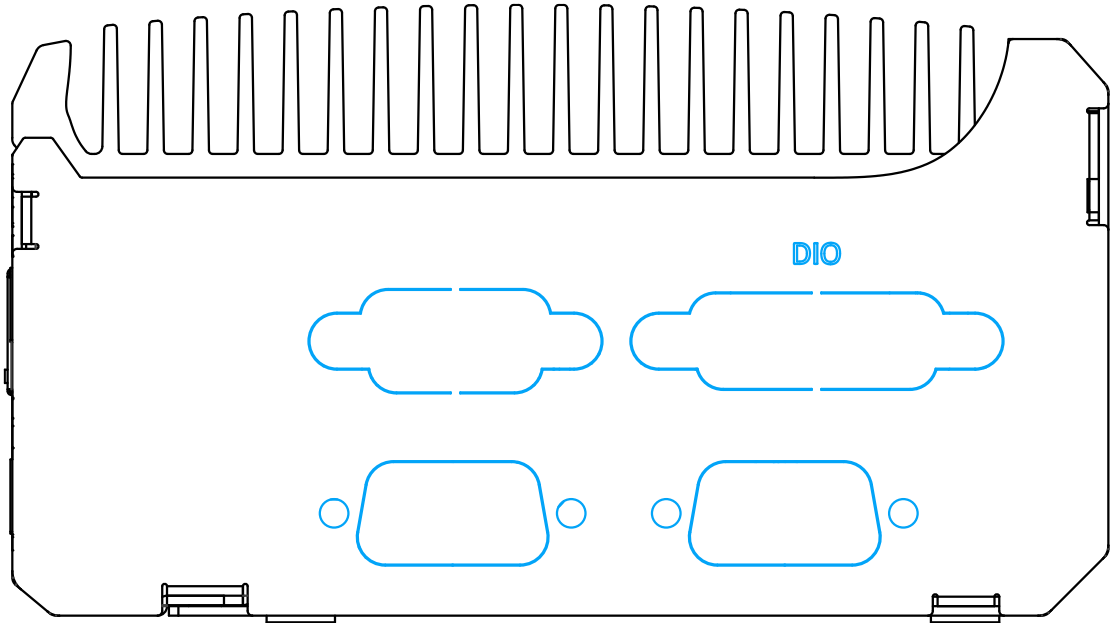

2.6 Internal I/O

The system's internal I/O connectors consist of an mini-PCIe slot with SIM slot, an M.2 slot for NVMe SSD, SO-DIMM socket, slot and a MezIO™ port for application-oriented expansion purposes.

2.6.1 Full-size mini-PCIe Slot and SIM Socket

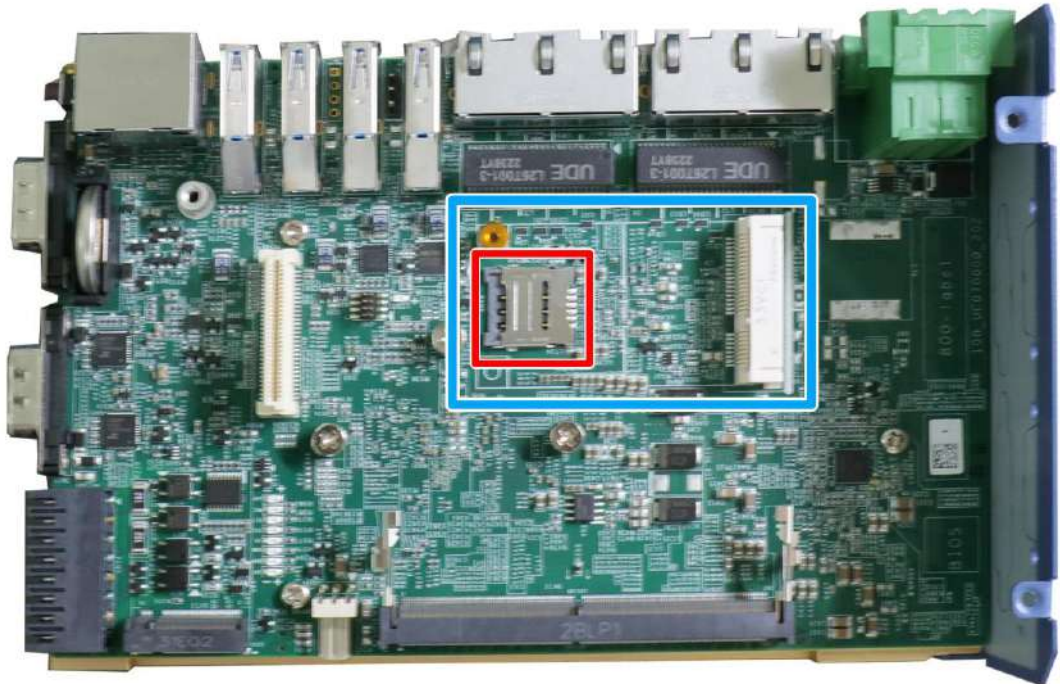

The system provides a full-size mini-PCIe socket (indicated in **blue**) designed with SIM card (indicated in **red**) support. With a SIM card installed, your system can access the internet via your network provider's 3G/ 4G network.

For wireless (WIFI/ 3G/ 4G) communication, there are SMA antenna openings on system side panels.

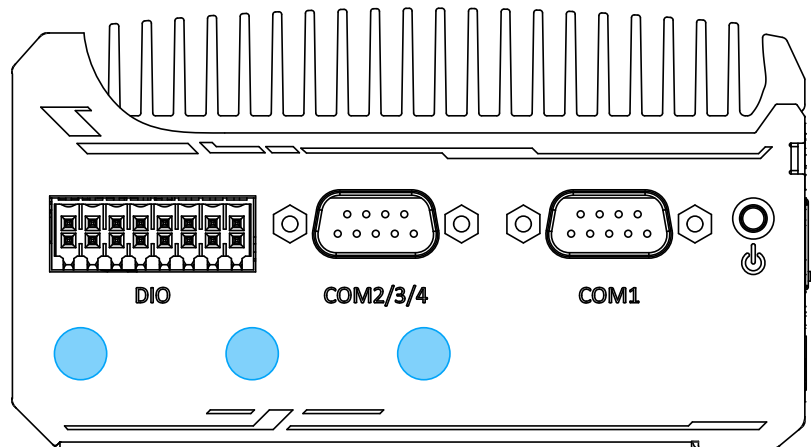

DIO/ COM port panel antenna openings

mini-PCIe Pin Definition

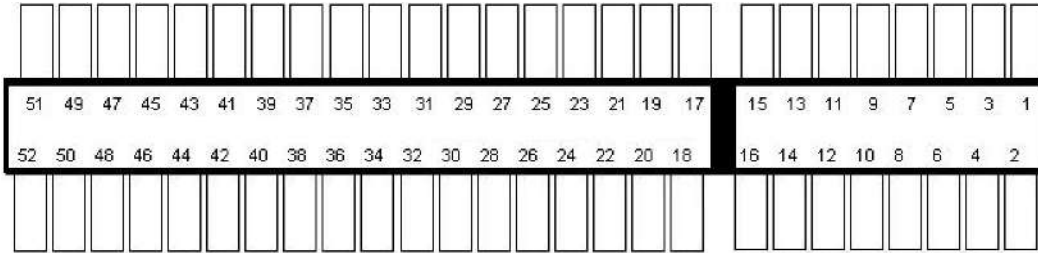

Pin #	Signal	Pin #	Signal
1	WAKE#	2	+3.3Vaux
3	COEX1	4	GND
5	COEX2	6	+1.5V
7	CLKREQ#	8	UIM_PWR
9	GND	10	UIM_DATA
11	REFCLK-	12	UIM_CLK
13	REFCLK+	14	UIM_RESET
15	GND	16	UIM_VPP
Mechanical Key			
17	Reserved* (UIM_C8)	18	GND
19	Reserved* (UIM_C4)	20	W_DISABLE#
21	GND	22	PERST#
23	PERn0	24	+3.3Vaux
25	PERp0	26	GND
27	GND	28	+1.5V
29	GND	30	SMB_CLK
31	PETn0	32	SMB_DATA
33	PETp0	34	GND
35	GND	36	USB_D-
37	GND	38	USB_D+
39	+3.3Vaux	40	GND
41	+3.3Vaux	42	LED_WWAN#
43	GND	44	LED_WLAN#
45	Reserved	46	LED_WPAN#
47	Reserved	48	+1.5V
49	Reserved	50	GND
51	Reserved	52	+3.3Vaux



WARNING

Some off-the-shelf mini-PCIe 4G modules use 1.8V I/O signals instead of 3.3V I/O and may cause signal interference. Installing an incompatible 4G module may damage the system or the module itself may be damaged. Please consult with Neousys when in doubt!

2.6.2 M.2 2280 (M Key) Slot for SSD

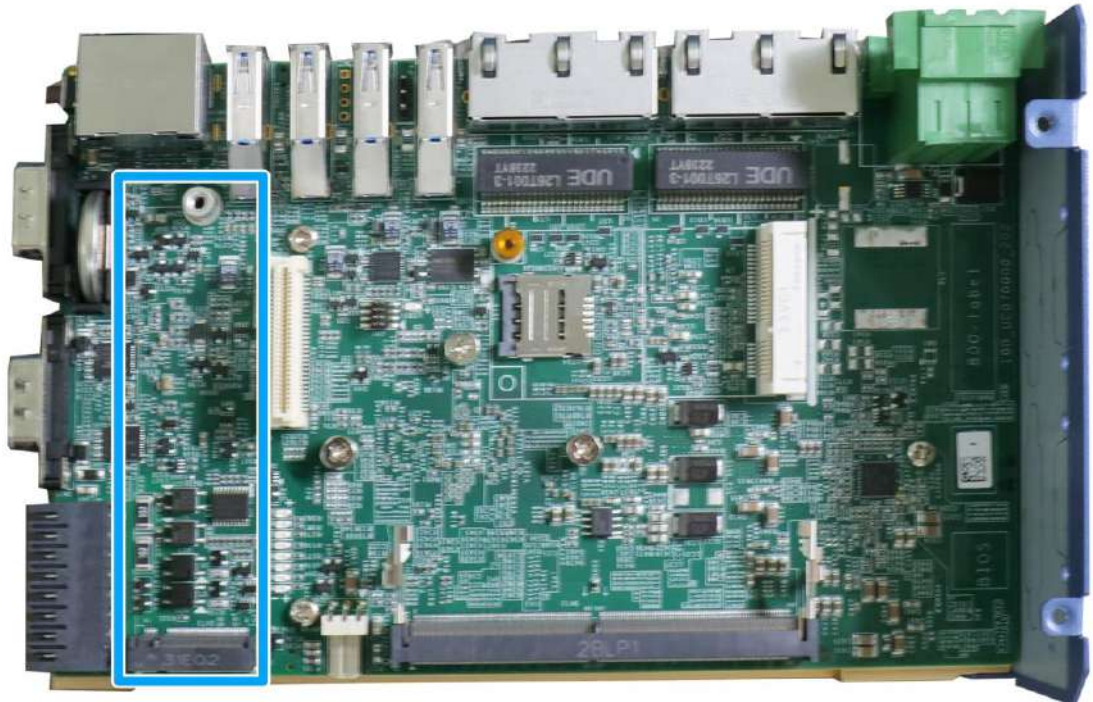

The system has an M key M.2 2280 slot supporting PCIe Gen3 x1 signal for NVMe SSD storage, and it also supports SATA signal for SATA SSD. Users can install an SSD for improved disk read/ write performance over mechanical hard drives or 2.5” SSDs.



NOTE

The M.2 slot will automatically detect and configure the slot to run PCIe or SATA signal depending on the installed device.

M.2 (M Key) Slot Pin Definition

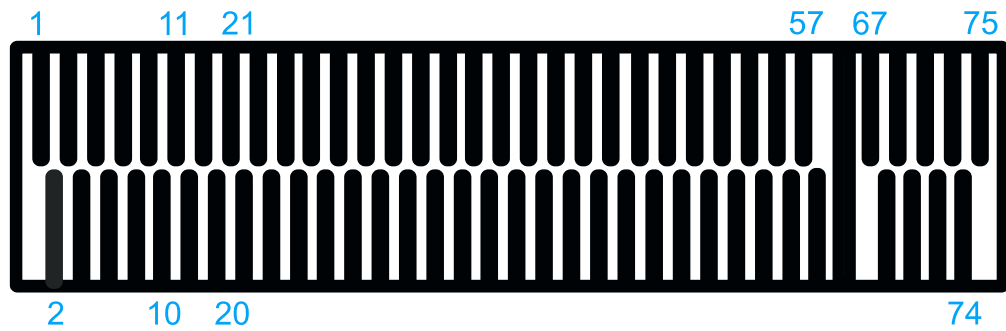

Pin #	Signal	Pin #	Signal
1	GND	2	+3V3
3	GND	4	+3V3
5	PERN3	6	-
7	PERP3	8	-
9	GND	10	DAS/DSS N
11	PETN3	12	+3V3
13	PETP3	14	+3V3
15	GND	16	+3V3
17	PERN2	18	+3V3
19	PERP2	20	-
21	GND	22	-
23	PETN2	24	-
25	PETP2	26	-
27	GND	28	-
29	PERN1	30	-
31	PERP1	32	-
33	GND	34	-
35	PETN1	36	-
37	PETP1	38	-
39	GND	40	-
41	PERn0 / SATA-B+	42	-
43	PERp0 / SATA-B-	44	-
45	GND	46	-
47	PETn0 / SATA-A-	48	-
49	PETp0 / SATA-A+	50	PERST N
51	GND	52	CLKREQ
53	REFCLKN	54	-
55	REFCLKP	56	-
57	GND	58	-
Mechanical Key			
67	-	68	SUSCLK
69	PEDET	70	+3V3
71	GND	72	+3V3
73	GND	74	+3V3
75	GND		

2.6.3 SO-DIMM Socket

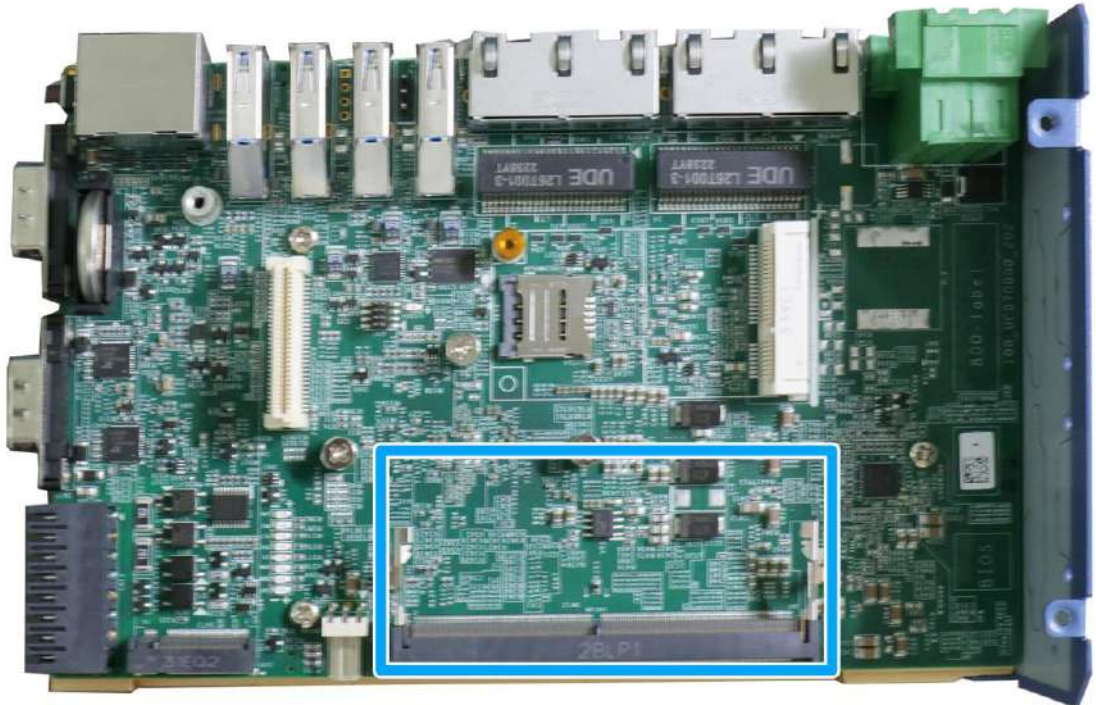

The system supports one SO-DIMM socket for installing DDR5-4800 memory module up to 16GB in capacity.

2.7 MezIO® Interface

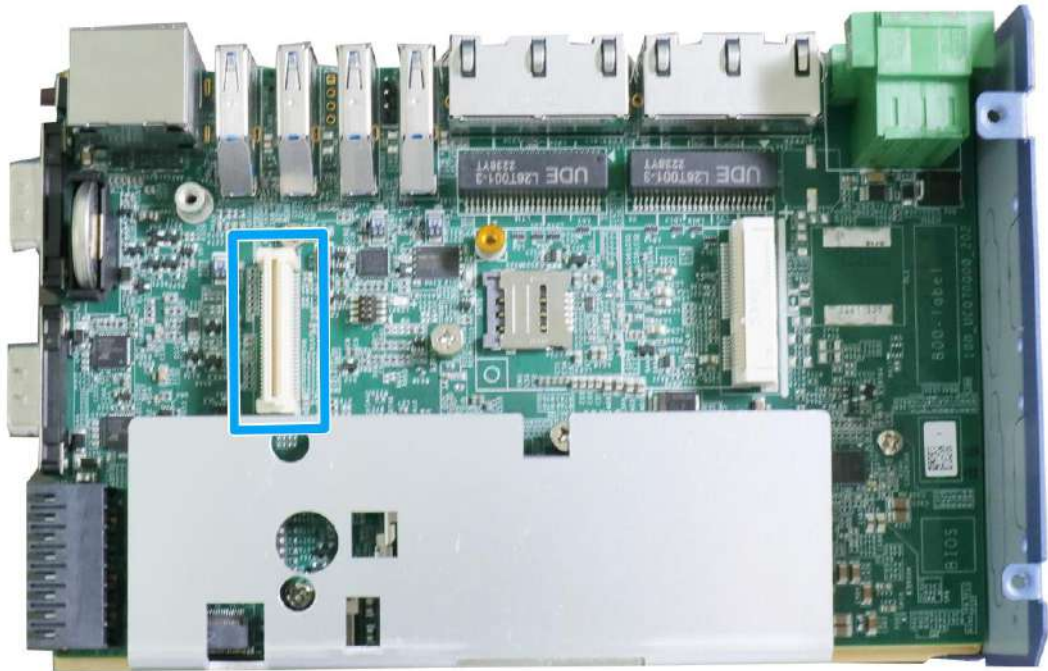

MezIO® is an innovative interface designed for integrating application-oriented I/O functions into an embedded system. It offers computer signals, power rails and control signals via a high-speed connector. MezIO® is also mechanically reliable benefited from its 3-point mounted mezzanine structure. A MezIO® module can leverage these signals to implement comprehensive I/O functions.

The system incorporates MezIO® interface and universal mechanical design to accommodate Neusys' standard MezIO® modules. For customers who want to develop their own MezIO® module, Neusys provides MezIO® design documents on a NDA basis. Please contact Neusys for further information.

2.7.1 MezIO® Interface Pin Definition

MezIO® interface leverages FCI BERGSTAK® board-to-board connector to provide interconnectivity of high-speed signals. The receptacle part on the PCBA is FCI 61082-063402LF while the plug part on the MezIO® module is FCI 61083-064402LF. Please refer to the following table for signal definition of its 60-pos connector.

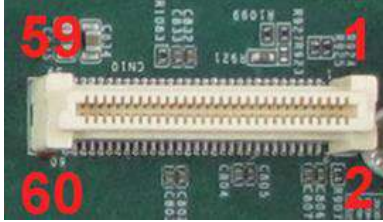

Function Description	Signal	Pin#	Pin#	Signal	Function Description
Reserved	Reserved	1	2	PCIE_TXP_0	PCle data pair
Reserved	Reserved	3	4	PCIE_TXN_0	PCle data pair
Reserved	Reserved	5	6	GND	Ground
Reserved	Reserved	7	8	PCIE_RXP_0	PCle data pair
System S4 signal	SLP_S4#	9	10	PCIE_RXN_0	PCle data pair
Ground	GND	11	12	CLK100_P_0	PCle clock pair
Reserved	Reserved	13	14	CLK100_N_0	PCle clock pair
Ground	GND	15	16	GND	Ground
Reserved	UID_LED	17	18	PCIE_TXP_1	PCle data pair
Platform reset signal	PLT_RST#	19	20	PCIE_TXN_1	PCle data pair
USB data pair	USBP5_N	21	22	PCIE_RXP_1	PCle data pair
USB data pair	USBP5_P	23	24	PCIE_RXN_1	PCle data pair
Ground	GND	25	26	GND	Ground
SMB bus	SMB_DATA	27	28	CLK100_P_1	PCle clock pair
SMB bus	SMB_CLK	29	30	CLK100_N_1	PCle clock pair
N/C	N/C	31	32	GND	Ground
N/C	N/C	33	34	N/C	N/C
Ground	GND	35	36	N/C	N/C
N/C	N/C	37	38	GND	Ground
N/C	N/C	39	40	N/C	N/C
Power button signal	PWRBTN#	41	42	N/C	N/C
Reserved	Reserved	43	44	RXD4	SIO COM4
PCH GPIO	GPIO_RISER3	45	46	TXD4	SIO COM4
PCH GPIO	GPIO_RISER2	47	48	RXD5	SIO COM5
PCH GPIO	GPIO_RISER1	49	50	TXD5	SIO COM5
Ground	GND	51	52	GND	Ground
3.3V power	P3V3	53	54	P1V8	1.8V power
3.3V power	P3V3	55	56	GND	Ground
5V power	P5V	57	58	P12V	12V power
5V power	P5V	59	60	P12V	12V power

2.7.2 MezIO® Modules for POC-700 Series

Neousys offers MezIO® modules to expand I/O functions for Neousys systems. With the addition of a MezIO® module into your system, it offers extra RS-232/ 422/ 485 ports, isolated digital I/ O, 2.5" HDD/ SSD accommodation or ignition power control.

Model	Description
MezIO-R11	SATA port
MezIO-R12	SATA port + 4x isolated DI/ & 4x isolated DO
MezIO-C180-50	4-port RS-232/ 422/ 485 + 4-port RS-232
MezIO-C181-50	4-port RS-232/ 422/ 485 + 4-port RS-422/ 485
MezIO-V20	16-mode ignition power control + 1x mini-PCIe socket
MezIO-U4	4-port USB 3.1 Gen1

3 System Installation

Before disassembling the system enclosure and installing components and modules, please make sure you have done the following:

- It is recommended that only qualified service personnel should install and service this product to avoid injury or damage to the system.
- Please observe all ESD procedures at all times to avoid damaging the equipment.
- Before disassembling your system, please make sure you have the module/ component you wish to install at hand and have all the necessary tools.
- Before disassembling your system, please make sure the system has powered off, all cables and antenna (power, video, data, etc.) are disconnected.
- Place the system on a flat and sturdy surface (remove from mounts or out of server cabinets) before proceeding with the installation/ replacement procedure.

3.1 Disassembling the System Enclosure

3.1.1 Disassembling POC-700

To install internal components such as M.2 SSD, memory module, mini-PCIe or MezIO® module, you need to disassemble the system enclosure. Please refer to the following procedures:

1. Remove the three (3) screws on the front I/O panel.



2. Remove the three (3) screws.



3. Remove the two (2) screws on the read panel.



4. Remove the four (4) hex bolt screws on the DIO/ COM port panel.



5. Separate the IO and bottom panel from the system



Remove front IO panel



Remove bottom panel

6. Unscrew the two (2) screws to remove the DRAM/ M.2 heat spreader.

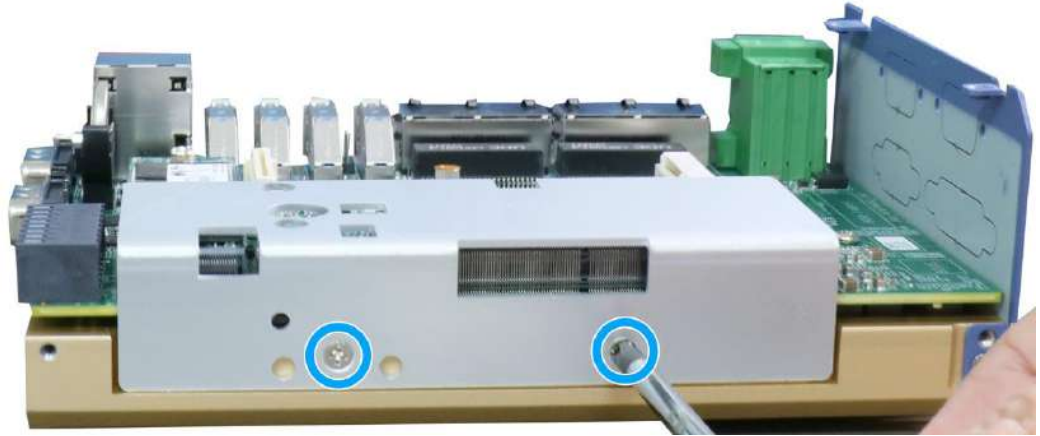

7. With external panels and DRAM/ M.2 heat spreader removed, you are ready to install internal components.
8. [Reinstall the enclosure](#) when done.

3.1.2 Disassembling POC-700-FT

 **NOTE**

Please place the system on a flat and sturdy surface to avoid damaging the thermal pad.

To install internal components such as M.2 SSD, memory module, mini-PCIe or MezIO® module, you need to disassemble the system enclosure. Please refer to the following procedures:

1. Remove the three (3) screws on the front I/O panel.



2. Remove the three (3) screws at the bottom.



3. Remove the two (2) screws on the read panel.



4. Remove the four (4) hex bolt screws on the DIO/ COM port panel.



5. Separate the IO and bottom panel from the system



Remove front IO panel

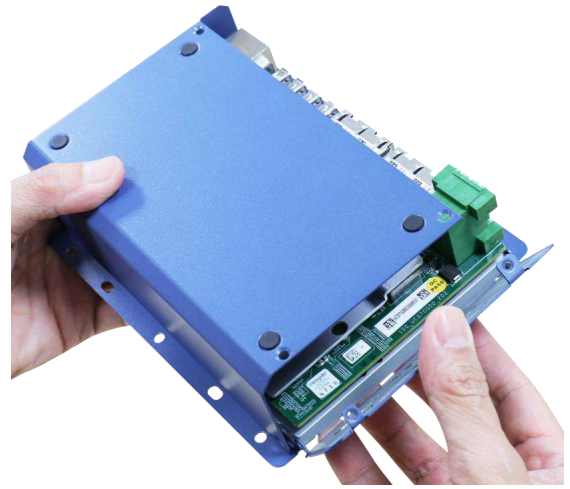

Remove reserved punch-out panel

6. Remove the bottom panel.



7. Unscrew the two (2) screws to remove the DRAM/ M.2 heat spreader.

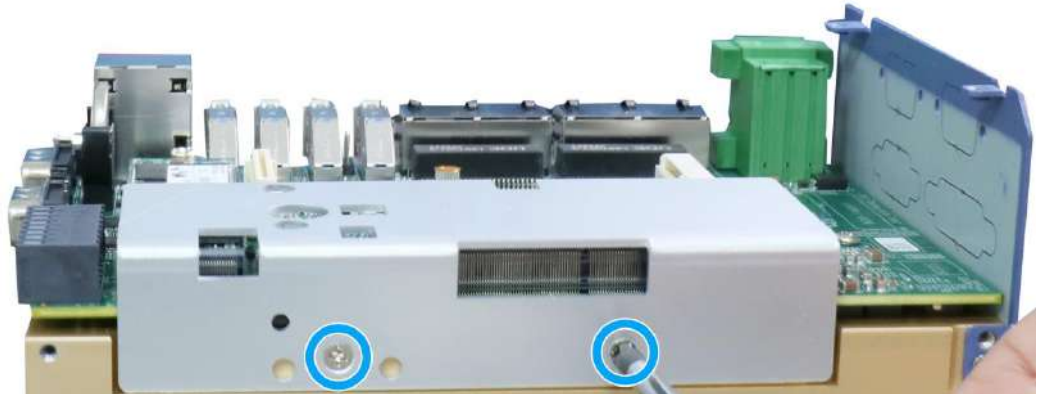

8. With external panels and DRAM/ M.2 heat spreader removed, you are ready to install internal components.

[Reinstall the enclosure](#) when done.

3.2 Installing Internal Components

3.2.1 DDR5 SO-DIMM Installation

There is one SO-DIMM memory slot on the motherboard. Please follow the procedures below to install the memory module.

1. [Disassemble the system enclosure.](#)
2. Locate the SO-DIMM slot on the motherboard shown once the enclosure and heat spreader have been removed.

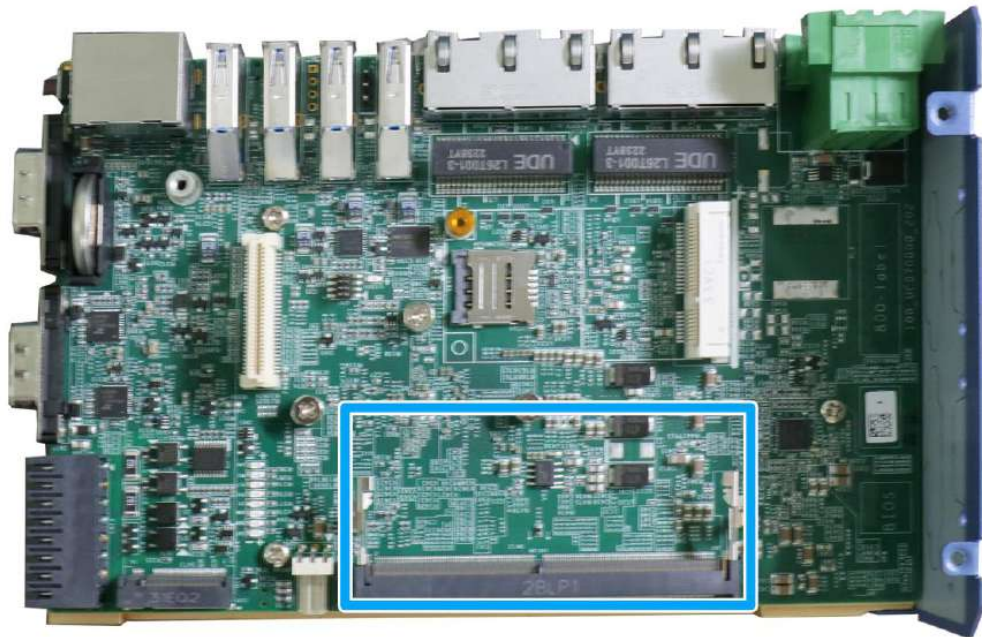

3. **To install**, insert the gold finger end of the SO-DIMM on a 45 degree angle into the slot and gently push the SO-DIMM down until it is clipped-in.

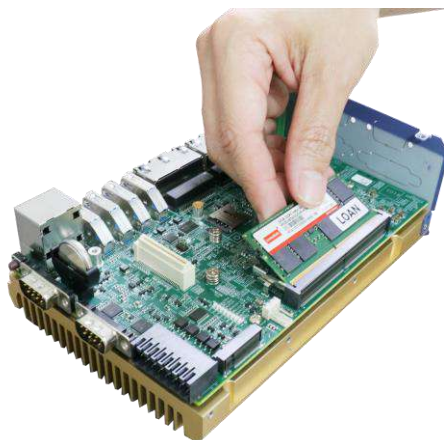

45 degree angle insert

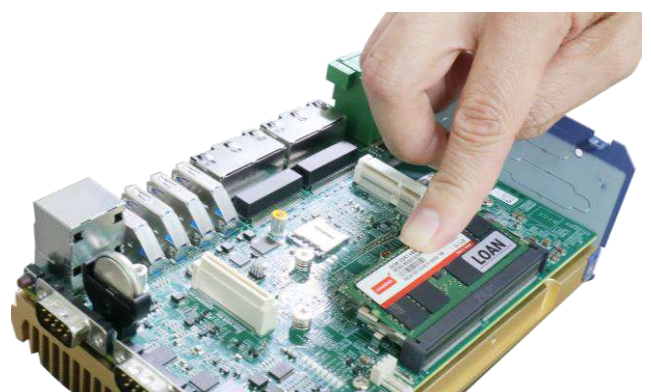

Push until it is clipped-in

4. Remove the protection film on the thermal pad.

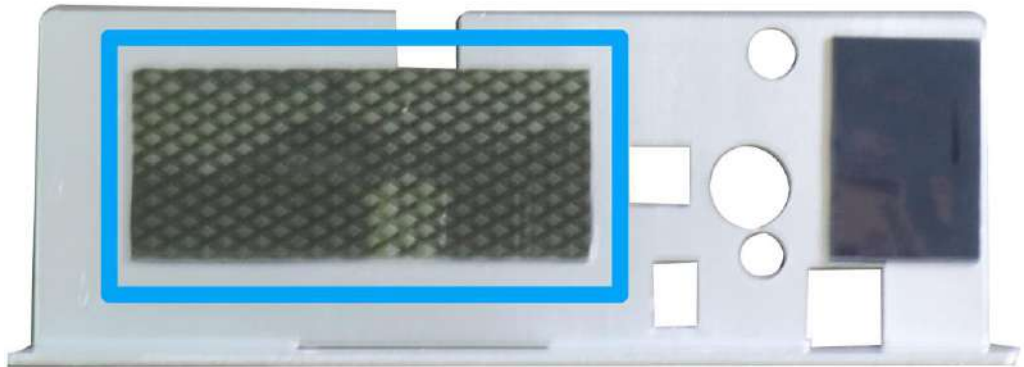

5. Secure the DRAM/ M.2 heatsink spreader onto the side of the system heatsink.



6. [Reinstall the enclosure](#) when done.

3.2.2 M.2 2280 M Key SSD Installation

There is one M.2 2280 M Key slot for you to install an SSD. Please follow the procedures below to install the M.2 SSD module.

1. [Disassemble the system enclosure.](#)
2. Located the M.2 2280 M Key slot once the system enclosure and heat spreader have been removed.

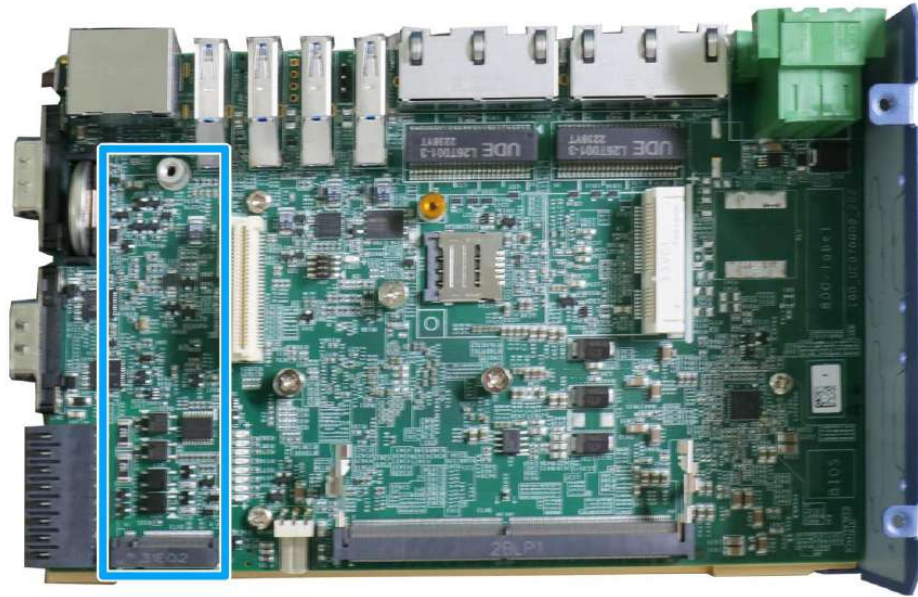

3. Insert the M.2 SSD into the slot on a 45° angle.

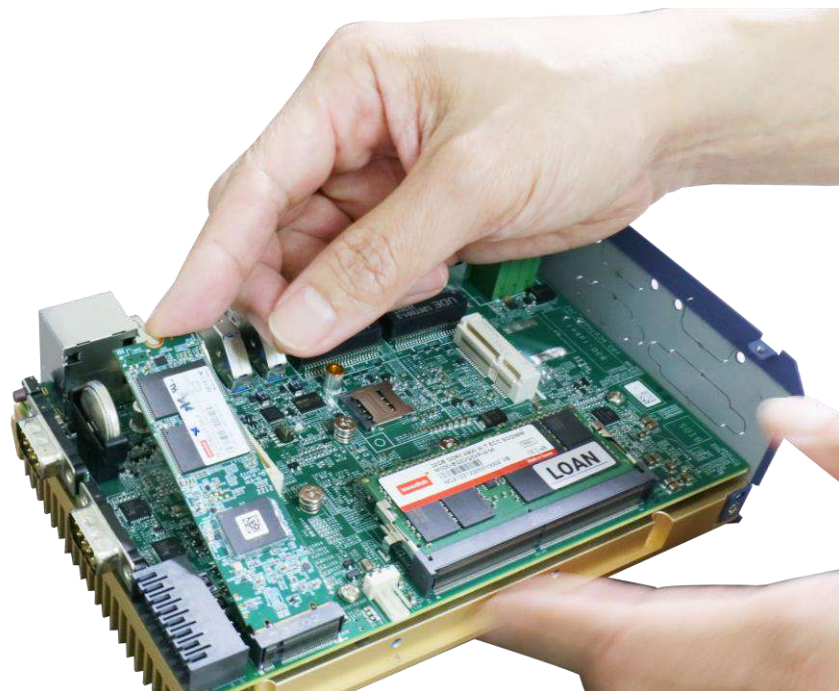

4. Gently push it towards the motherboard and secure the NVMe SSD with the supplied screw.

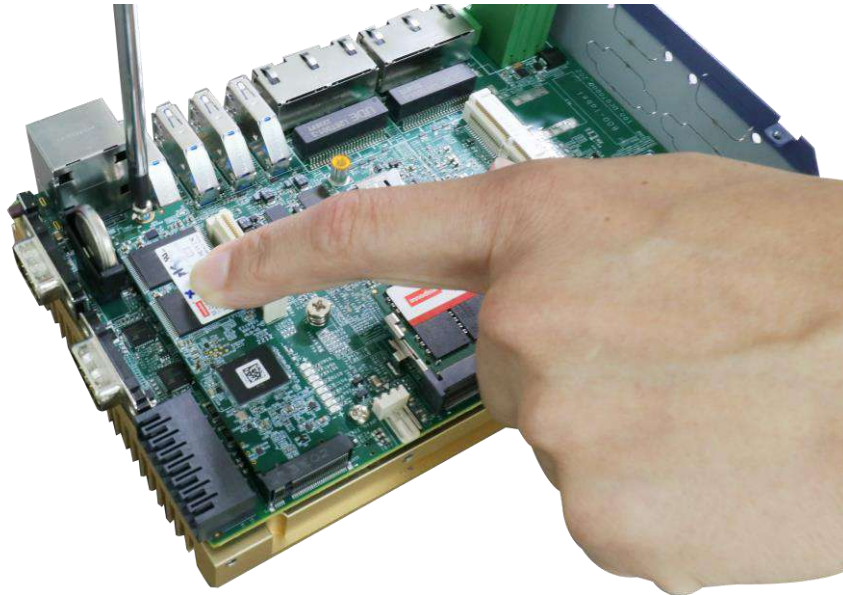

5. Once you have installed the NVMe SSD, you need to reinstall the heat spreader but before you do so, please make sure the protective film on the thermal pads have been removed.

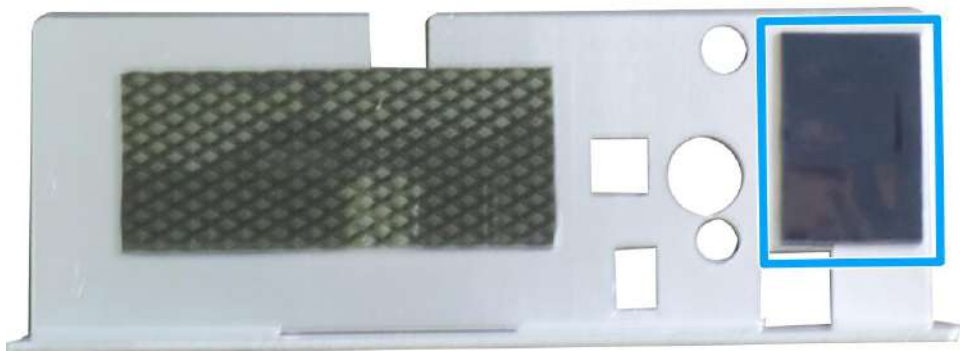

6. Secure the heat spreader by securing the two screws (indicated in red).

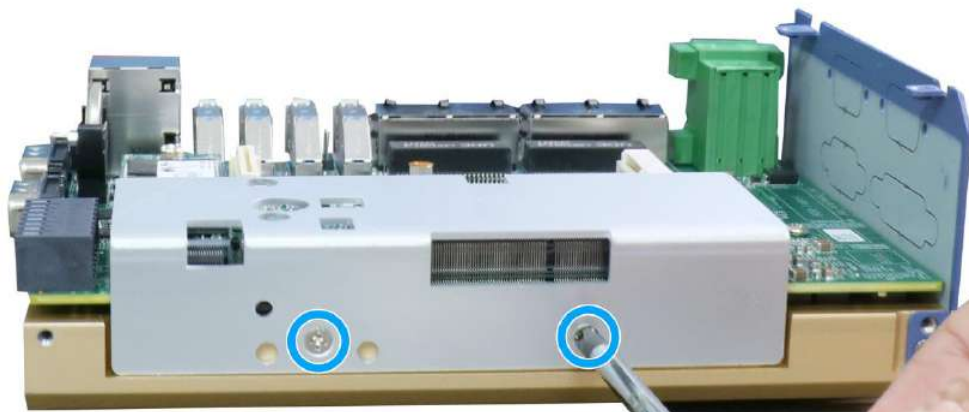

7. [Reinstall the enclosure](#) when done.

3.2.3 mini-PCIe Module, SIM Card and Antenna Installation

There are mini-PCIe with SIM slots on MezIO™ module and the motherboard. Please follow the procedures below to install the mini-PCIe module and SIM card, as well as the antenna for wireless communication.

1. [Disassemble the system enclosure.](#)
2. The mini-PCIe and SIM slots are shown in the illustration below.

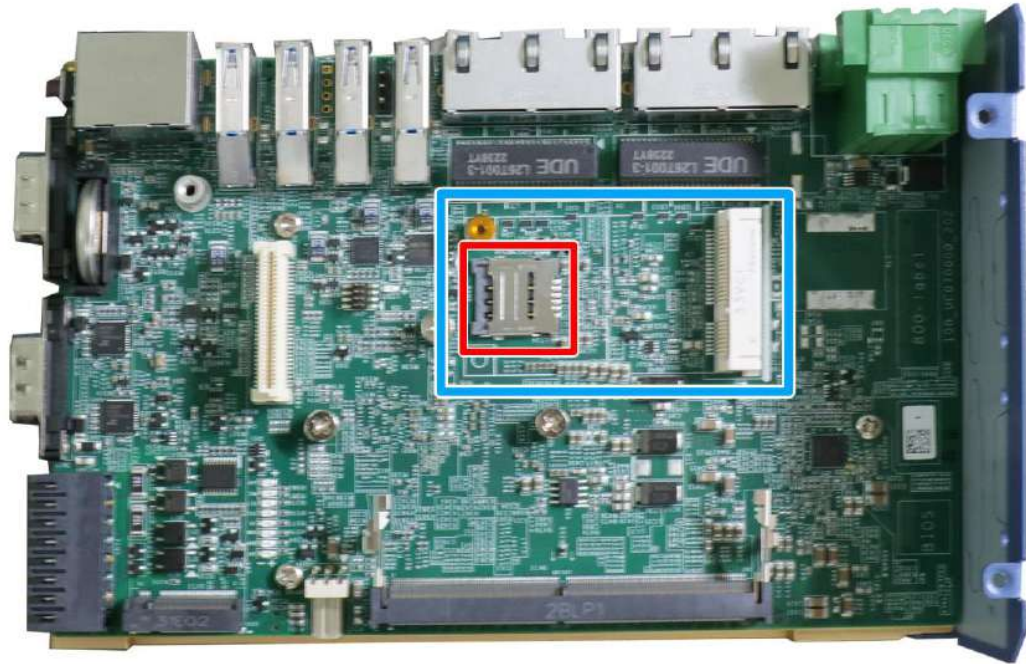

3. If you are installing a 4G/ 3G wireless module that requires a SIM, please install the SIM card first. Otherwise go to the next step. Push the SIM slot holder in the direction shown and flip open the holder to place the SIM into the slot.

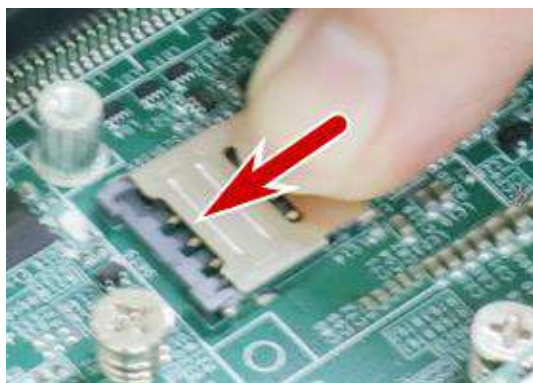

Push the SIM holder in the direction shown Flip open the holder and place SIM

4. Flip the holder back onto the SIM card and push in the direction shown to lock-in the SIM card into the slot.

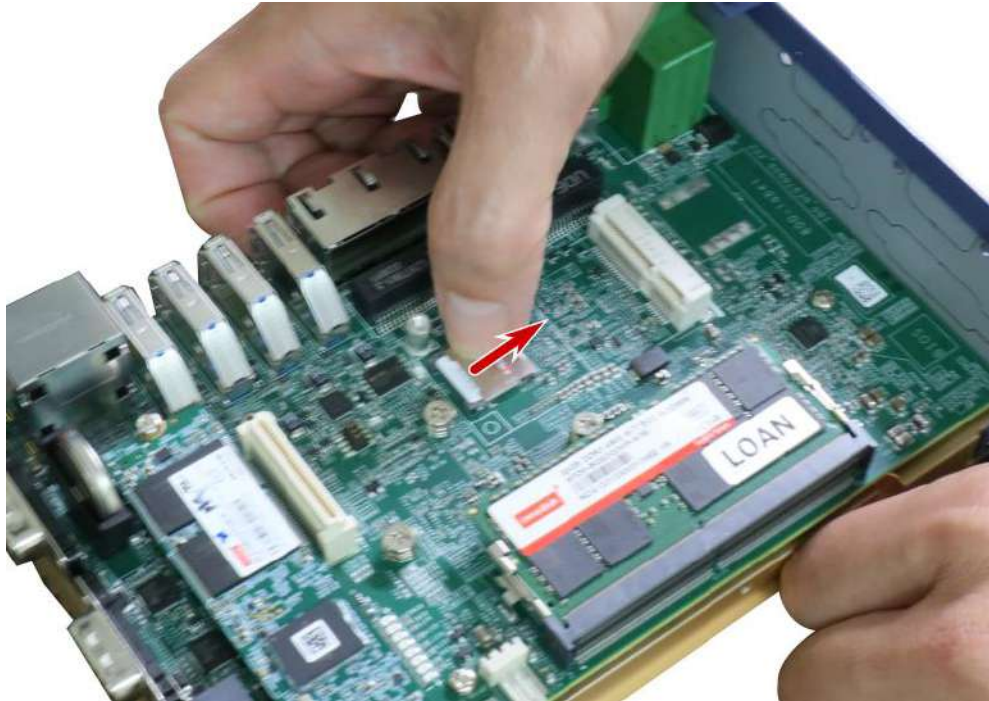

5. **To install**, insert mini-PCIe module's gold finger on a 45 degree angle into the socket, gently press the module down and secure it with a screw.



Insert on a 45 degree angle

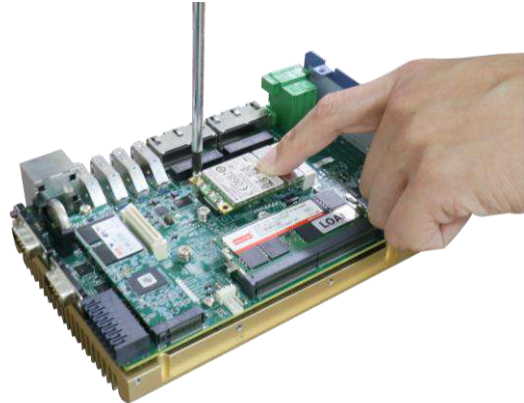

Secure the module with a screw

- Clip-on mini-PCIe module's antenna (please refer to the module's user manual on antenna cable connection).

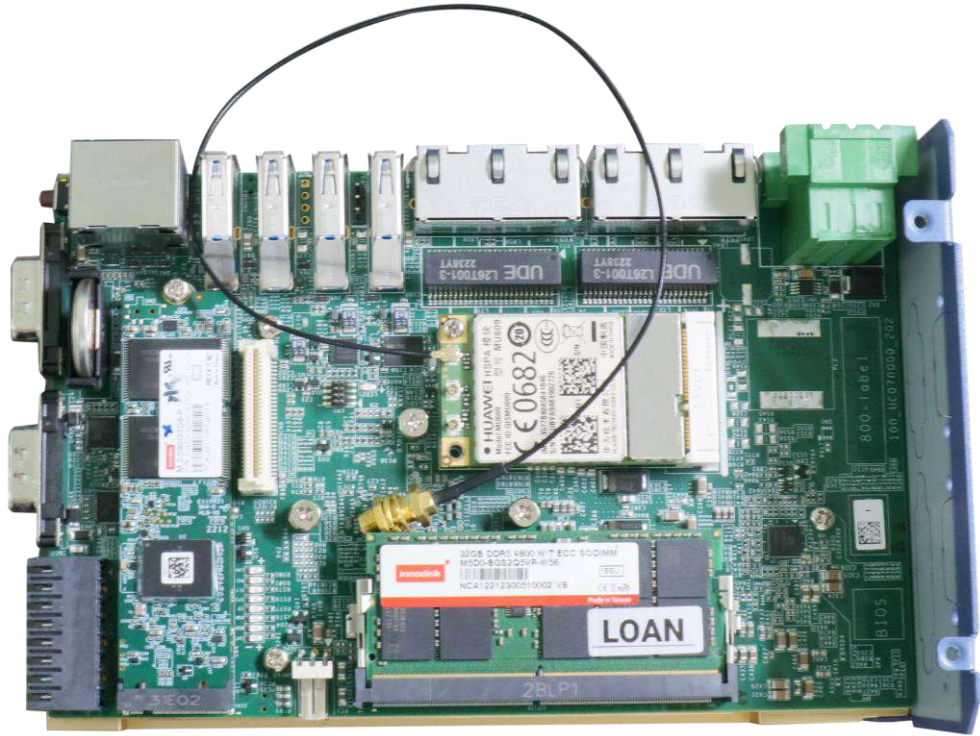

- Remove one of the antenna covers from the enclosure.

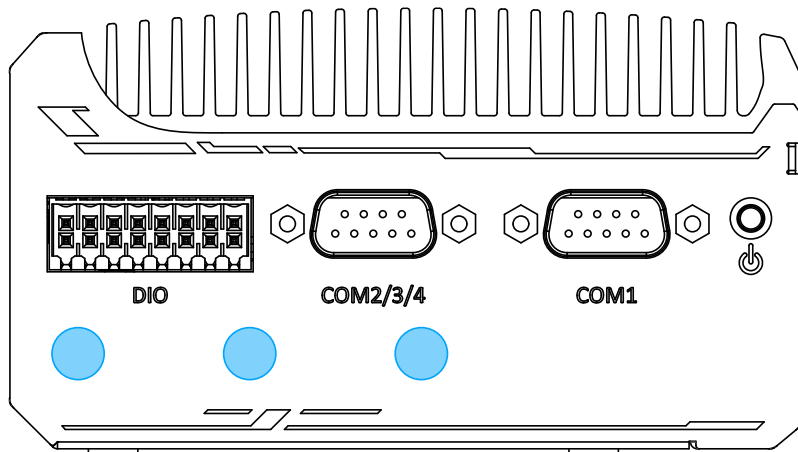

- Secure the SMA antenna connector, [reinstall the enclosure](#) and attach the external SMA antenna.

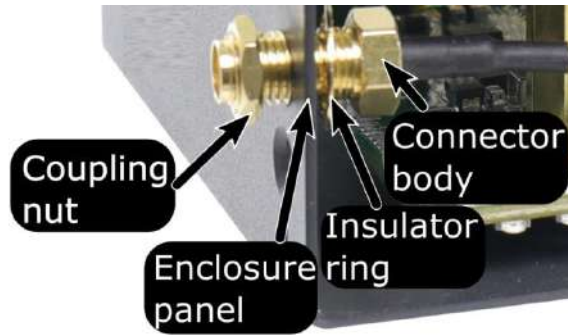

Securing antenna connection



Attach external antenna

- [Reinstall the enclosure](#) when done.

3.2.4 MezIO® Module Installation

The MezIO® module is situated above the heat spreader. Please make sure that you have installed the memory module, mini-PCIe, SIM card, NVMe SSD before installing the MezIO® module. To install the MezIO® module, please refer to the following procedure.

1. The MezIO® module connector can be located on the motherboard.

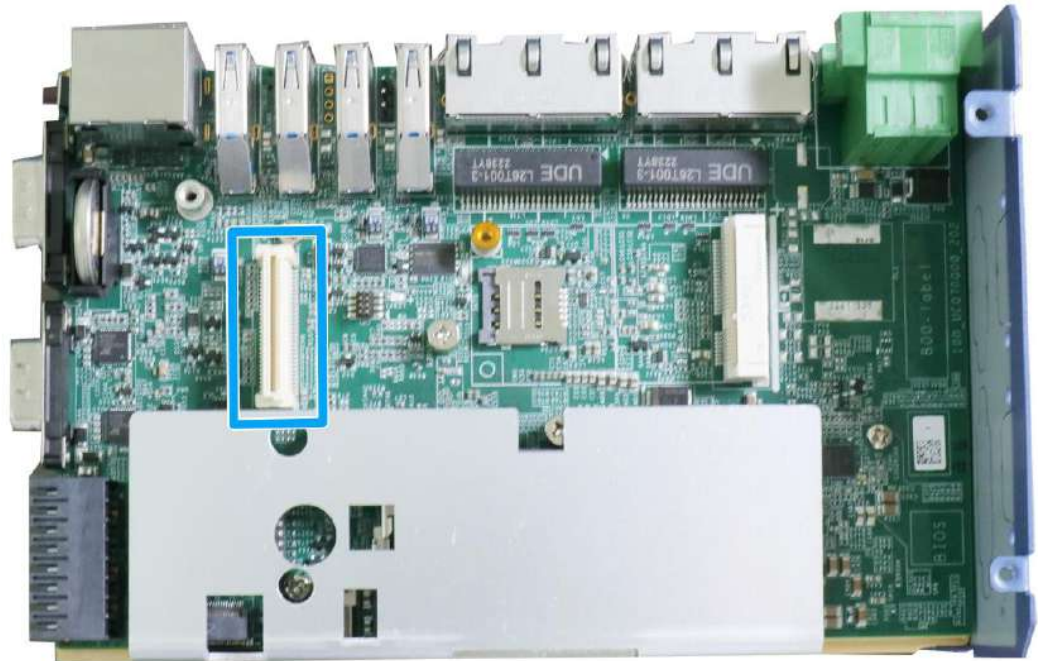

2. Please refer to [Disassemble the system enclosure](#).
3. Remove the reserved MezIO® connector panel by removing the screw indicated.

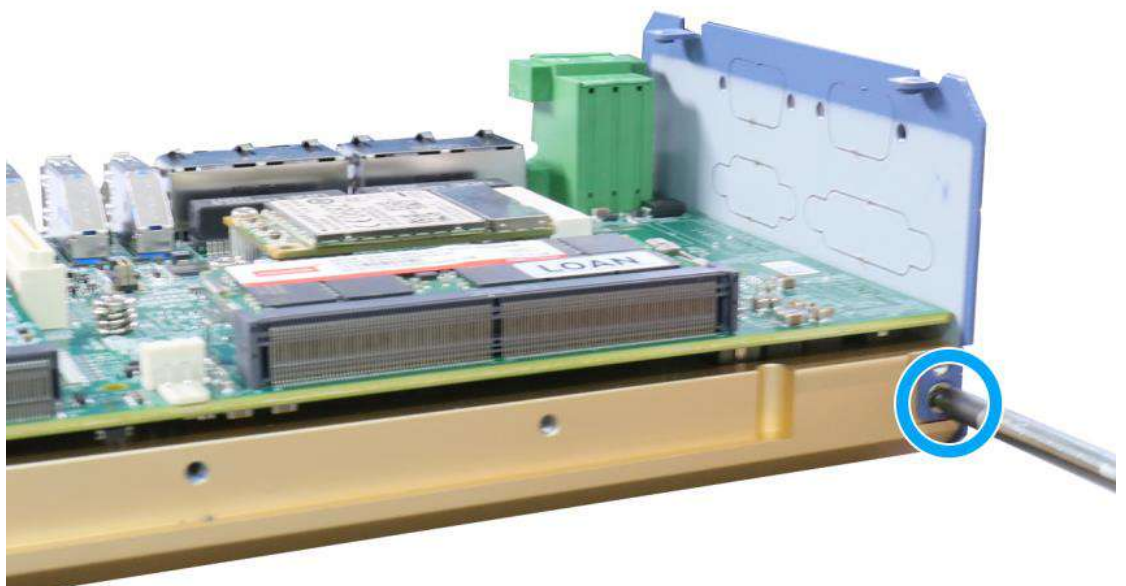

4. Remove the screws indicated and replace with stand-off hex bolt screws.



Hex bolt screw locations

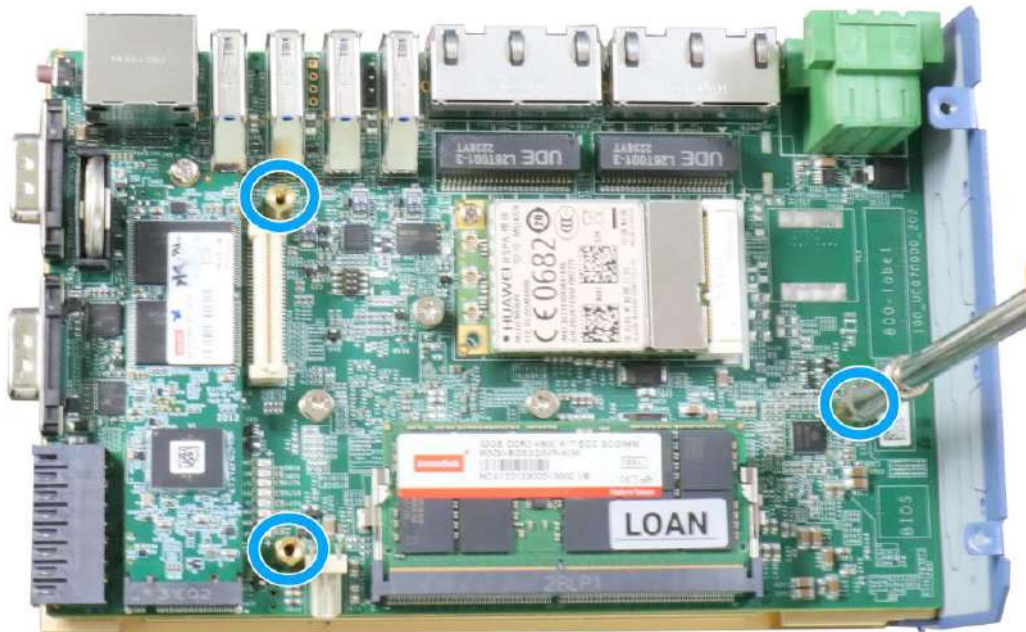

Stand-off hex bolt screws

- Gently lower the module onto the motherboard. Install the panel that came with the MezIO® module you ordered by securing the screw indicated.

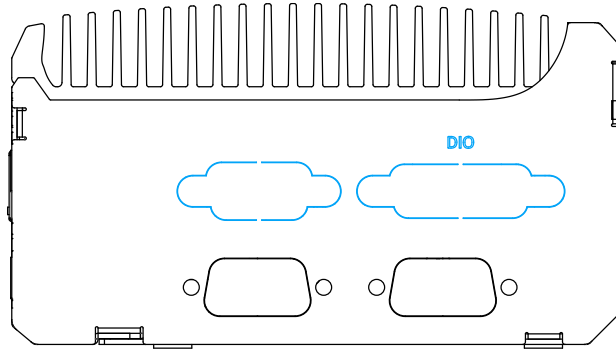

Remove the corresponding punch out plates (may differ depending on your MezIO® module) Secure the screw

- connector should engage the port if the three (3) standoffs and screw holes meet. Secure the module with three (3) P-head screws.



- [Reinstall the system enclosure](#) when done.

3.3 Installing the System Enclosure

3.3.1 Installing POC-700's Enclosure

1. Install the bottom/ rear enclosure panel



2. Install the front panel and securing it with three (3) screws.



- Secure the bottom and rear panel with screws.



Bottom panel screws



Rear panel screws

- Secure the hex bolt screws on the DIO/ COM port panel to complete the enclosure installation.



3.3.2 Installing POC-700-FT's Enclosure



NOTE

Please place the system on a flat and sturdy surface to avoid damaging the thermal pad.

1. Install the L-shaped bottom/ rear panel.



2. Install the reserved punch-out panel.



3. Assemble the front panel.



4. Secure the front panel with screws indicated.



- Secure the bottom with screws indicated.



- Secure the hex bolt screws on the DIO/ COM port panel to complete the enclosure installation.



3.4 POC-700 DIN Rail Installation

The system comes with a DIN rail clip (in the accessory box) that allows the system to be mounted vertically.

1. To install, secure the DIN rail clip (indicated in **red**) to the rear side panel of the system enclosure using the M4 screws (indicated in **blue**) provided.

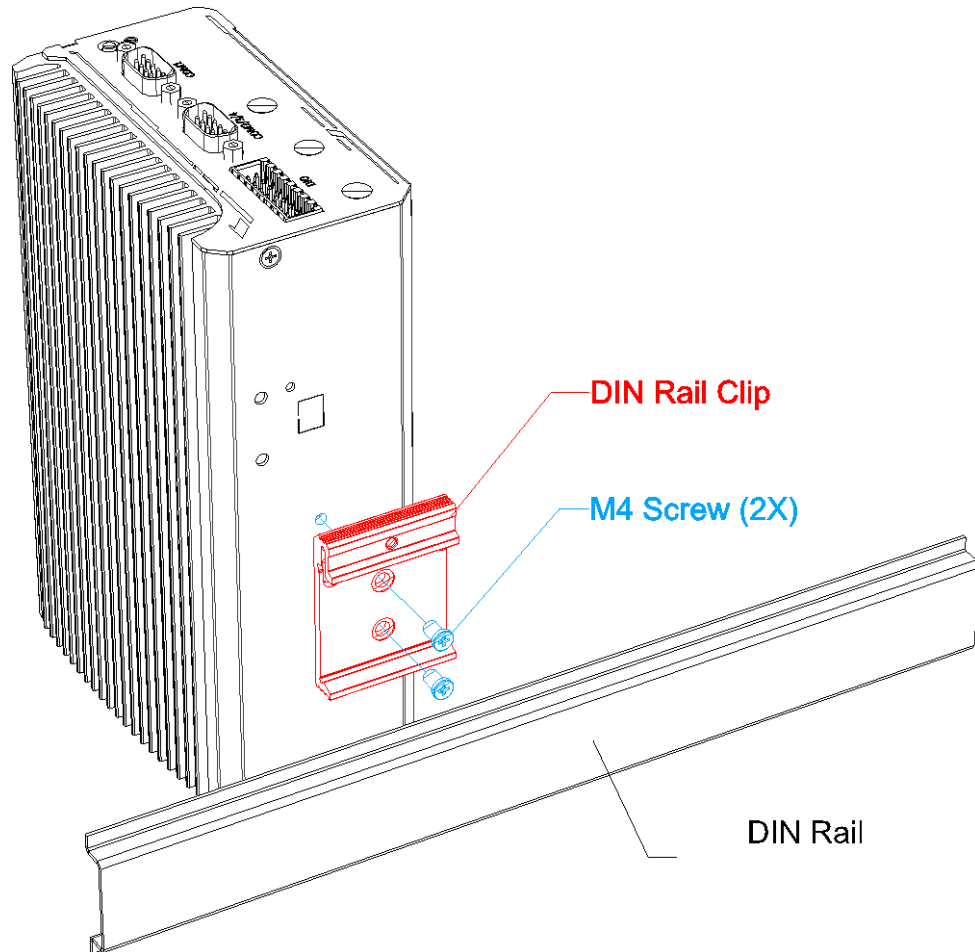

- To install the DIN rail clip onto the DIN rail, you must come over the top of the DIN rail, tilting, overlap the top clip edge of the DIN rail clip onto the DIN rail first, and then firmly press the bottom-front of the enclosure to clip the bottom edge of the mount plate.

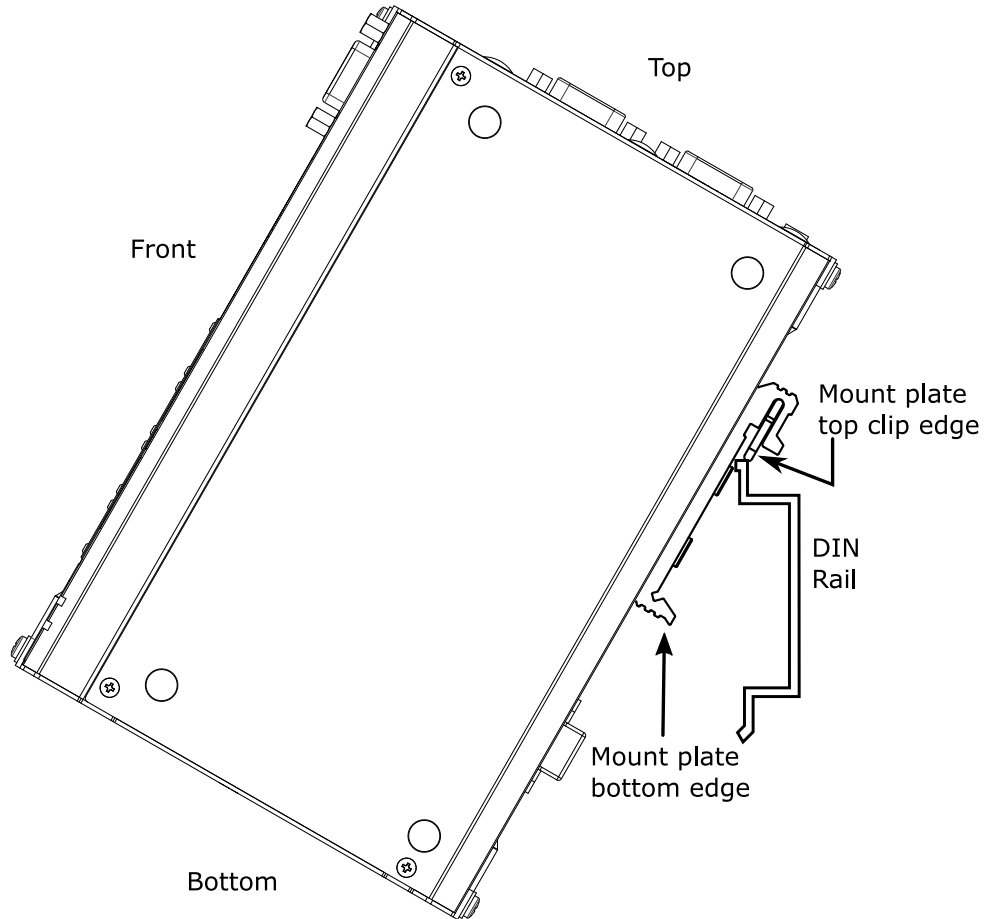

3. Confirm the mount plate has indeed clipped onto the DIN rail for proper fit to complete the installation.

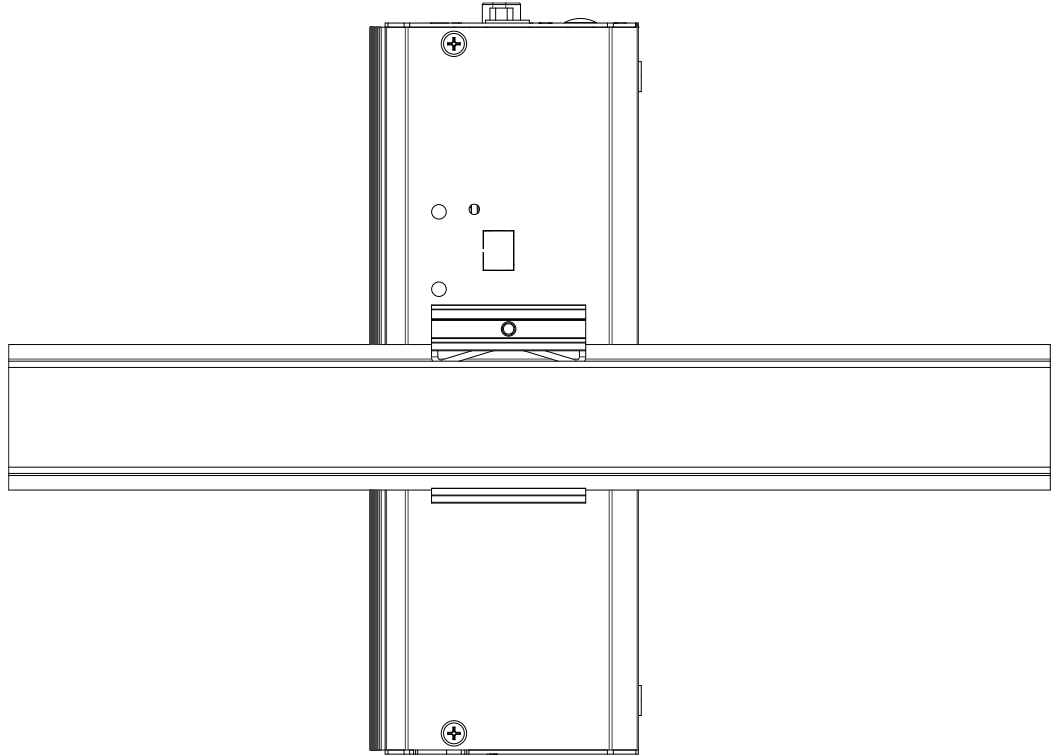

3.5 POC-700 Horizontal Wall Mount Installation (Optional)

The optional horizontal wall mount bracket allows the system to be mounted horizontally. Please refer to the following installation procedure:

1. Remove the rubber stands to access the M4 tapping (indicated in **green**).

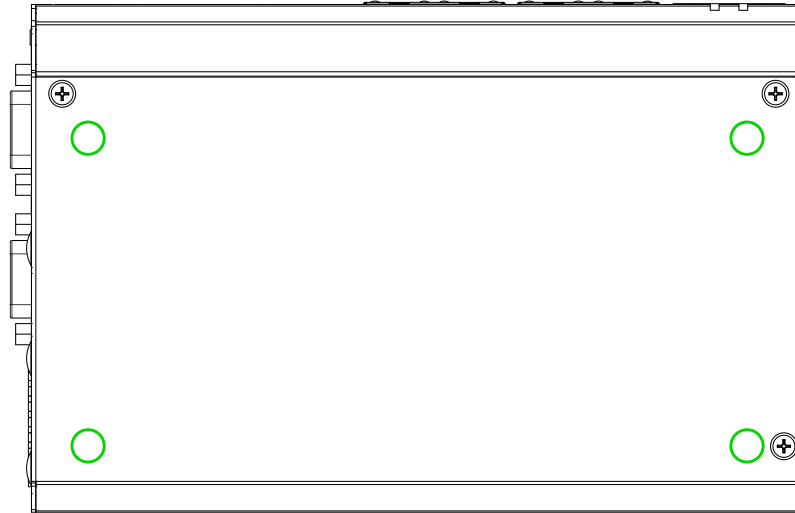

2. To install, secure the wall mount bracket (indicated in **red**) to the bottom of the system enclosure using the M4 screws (indicated in **blue**) provided.

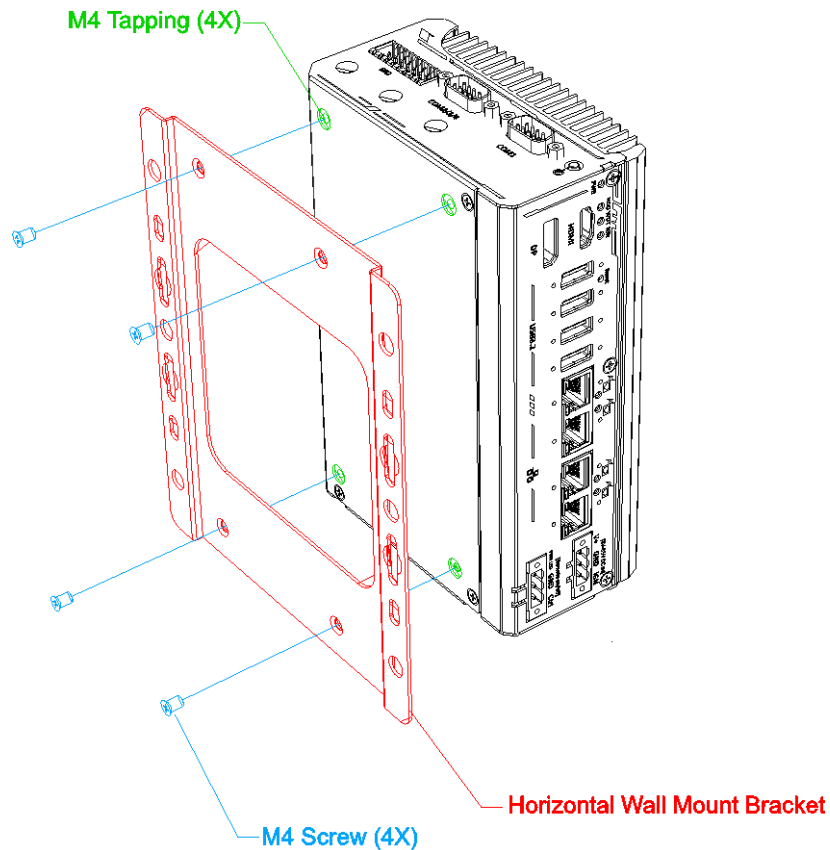

3. Dimension illustration of the installed horizontal wall mount bracket for your reference.

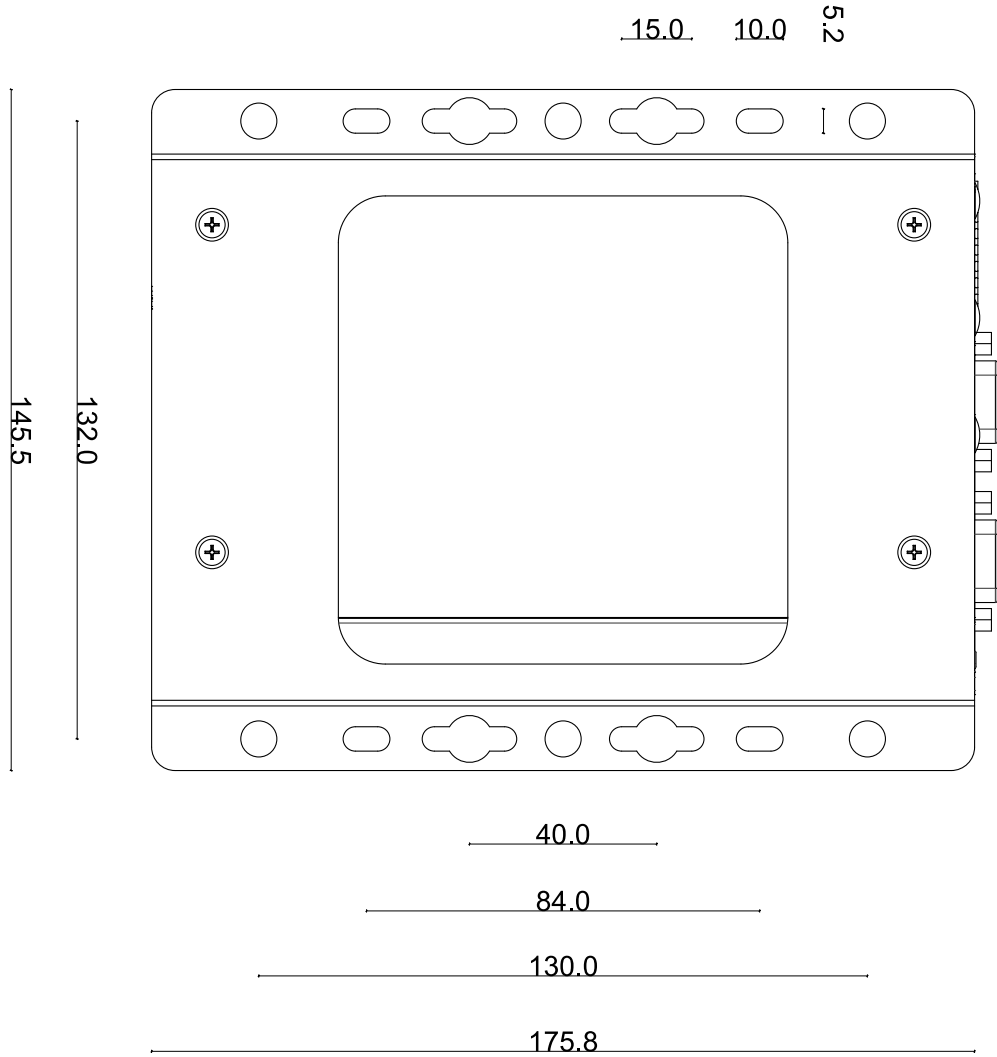

3.5.1 POC-700 Vertical Wall Mount Bracket (Optional)

- To install, secure the vertical wall mount bracket (indicated in red) to the rear panel of the system using the M4 screws provided (indicated in blue).

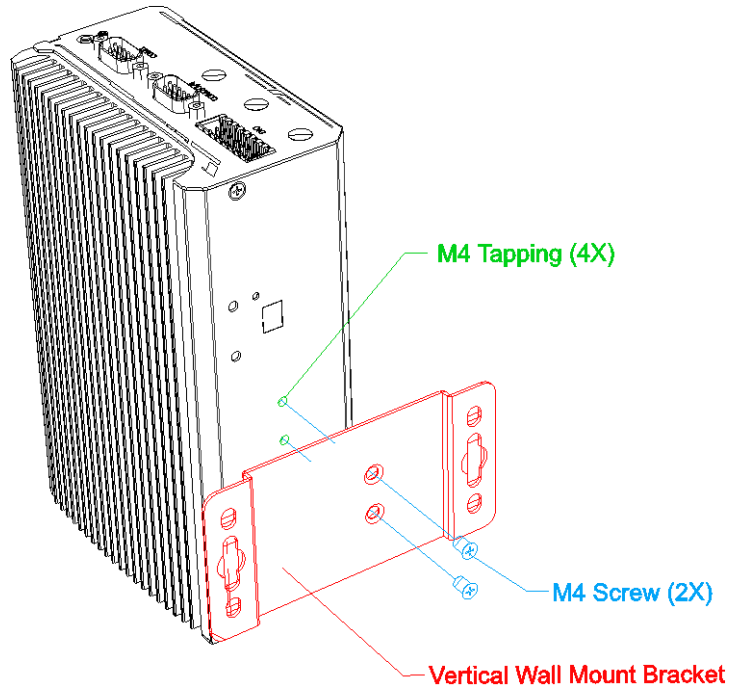

- Dimension illustration of the install vertical wall mount bracket for your reference.

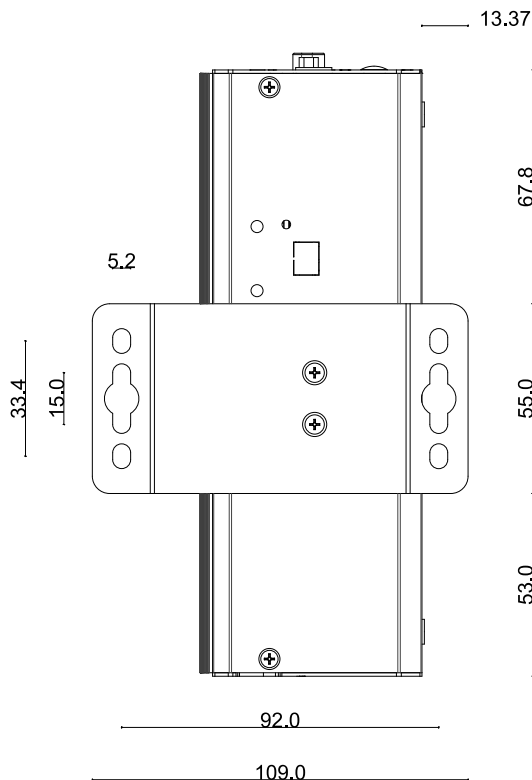

3.6 Mounting POC-700-FT

3.6.1 Mounting POC-700-FT

To mount POC-700-FT, please refer to the following procedure:

1. Note the distances between the screw-holes (indicated in green).

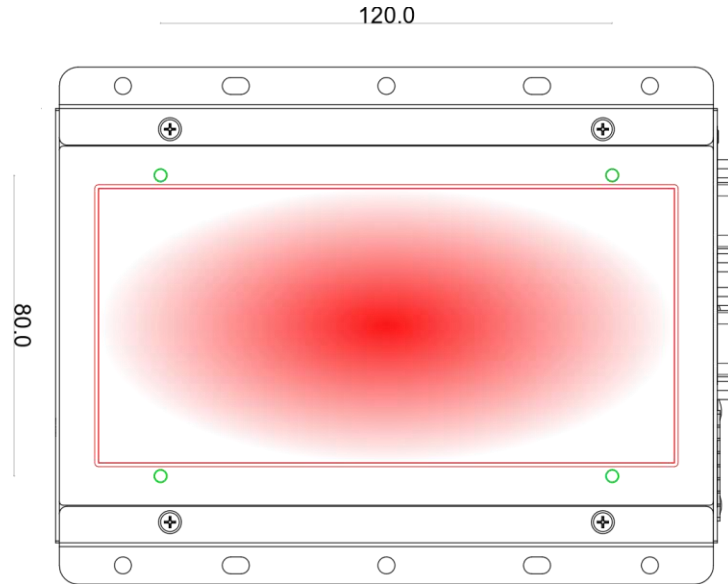

2. Find a flat spot on a metallic surface (eg. Inside of an enclosure wall), position the system approximately at the center of the flat surface, and secure with the screws indicated

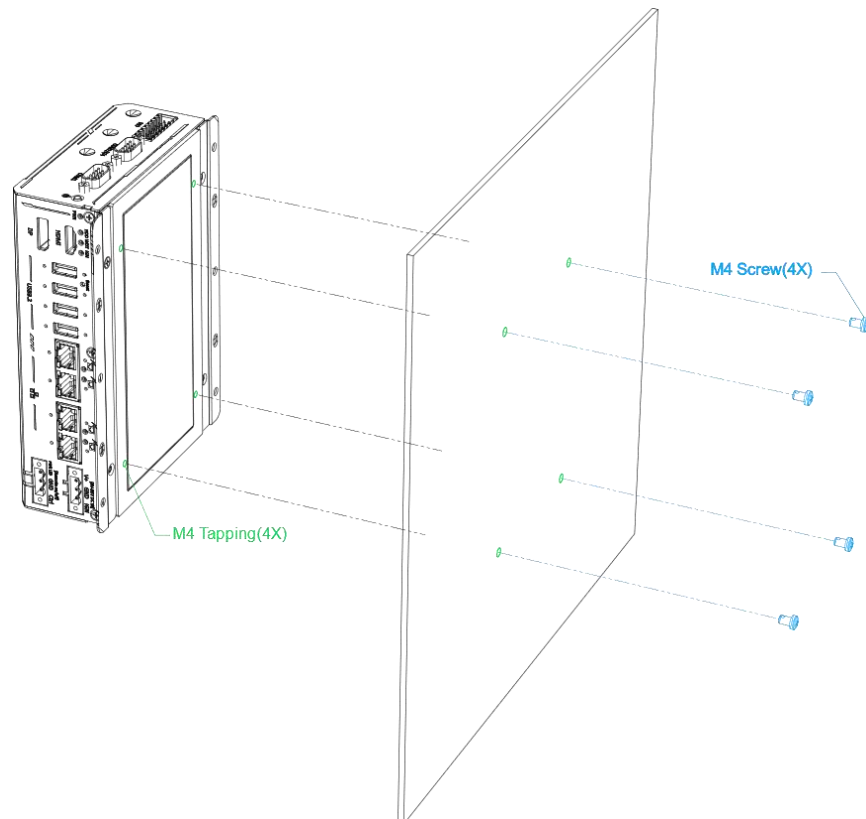

3.6.2 Mounting POC-700-FT Using Brackets

To mount POC-700-FT using brackets, please refer to the following procedure:

1. The mounting brackets will have the following dimensions, and the area indicated in red is the flattop heatsink contact area.

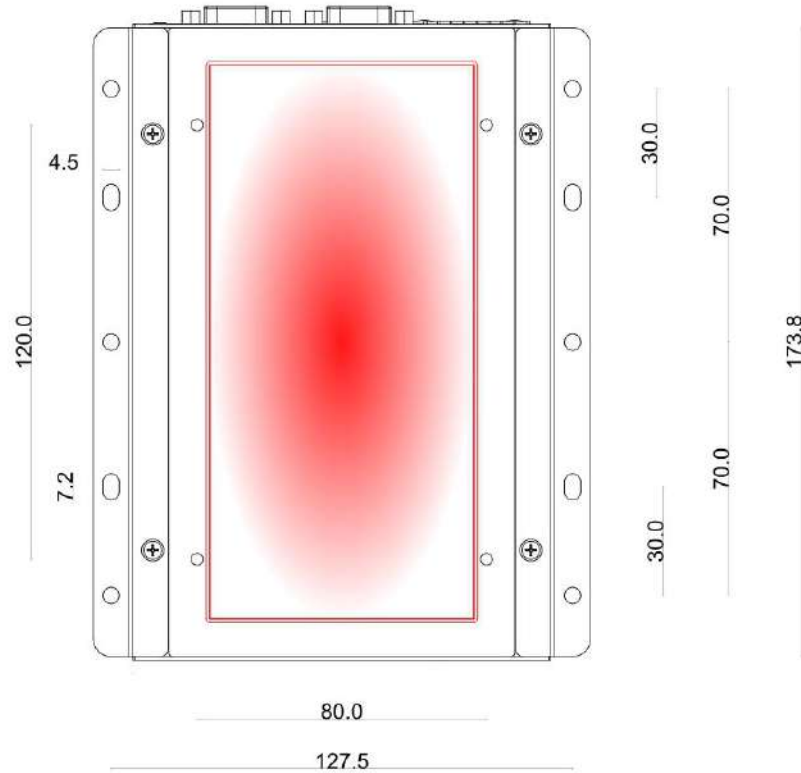

2. To wall mount POC-700-FT using brackets, you need to secure the system using the screw holes indicated in **blue**. Make note of the screw hole distances.

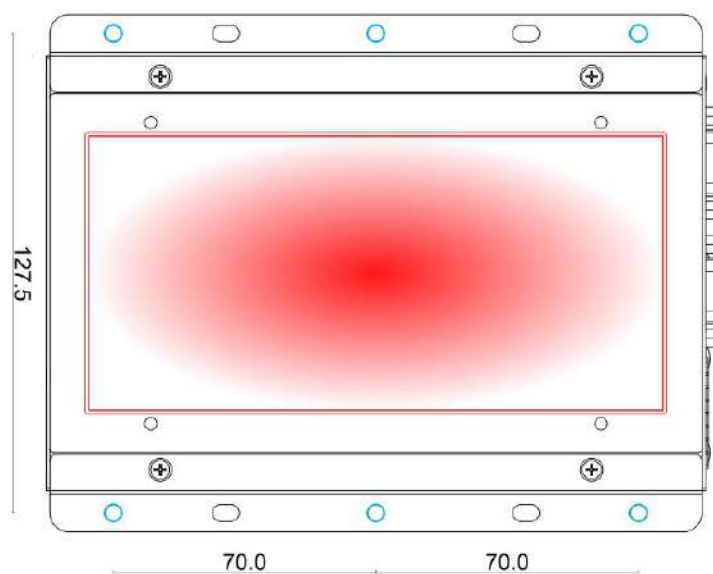

3. Find a flat spot on a metallic surface (eg. Inside of an enclosure wall), position the system approximately at the center of the flat surface, and secure with the screws indicated.

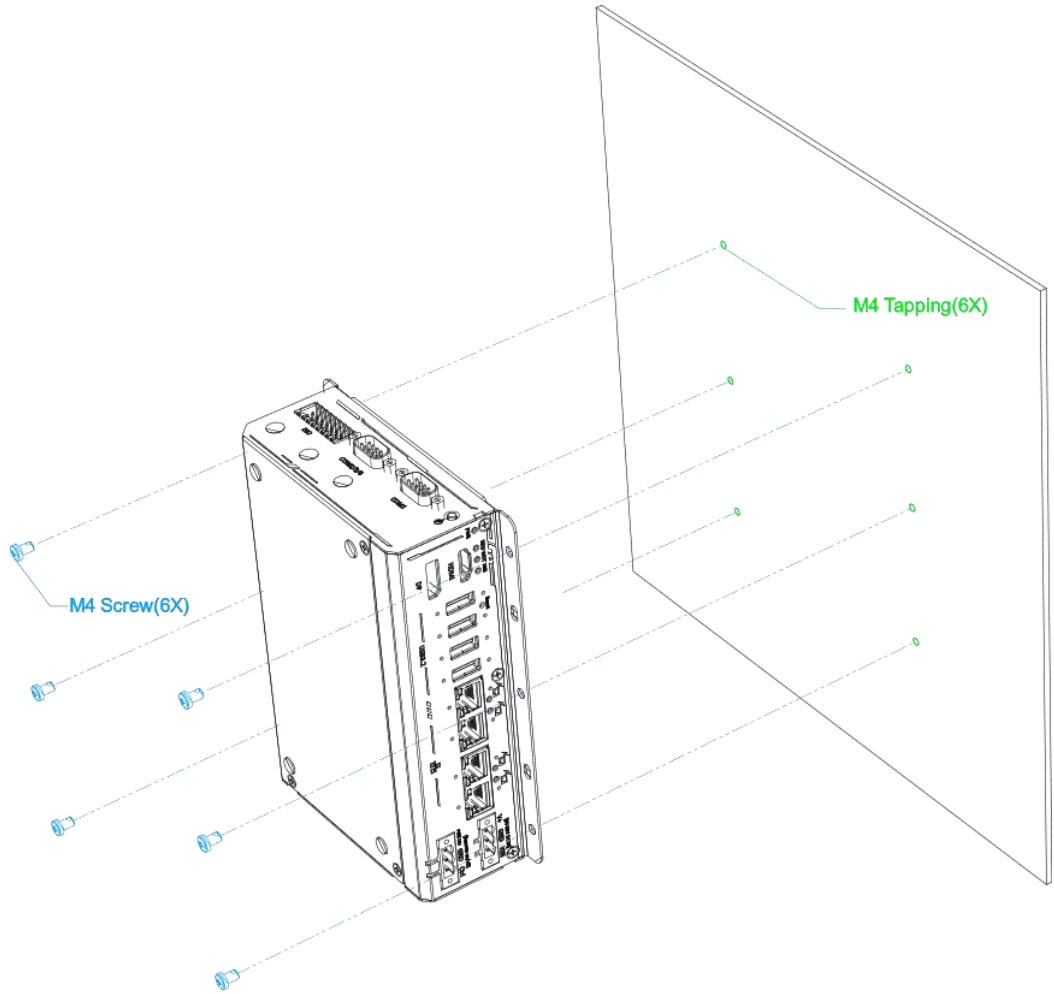

3.7 Fan Kit Installation (Optional)

The optional fan kit is only applicable to POC-700 system when operating in specific environments. To install the optional fan kit, please refer to the following procedure.

1. Place the fan on top of the system's heatsink and secure it with the screws (on front and rear panels) and beware of the orientation of the fan as the fan's power cable must within reach of the 4-pin fan power connector (on the rear panel).



With front panel (the panel with Ethernet/ USB, etc.) facing you, the fan's power connector should be on the left, just around the corner from USB ports.



Front panel screws



Rear panel screws

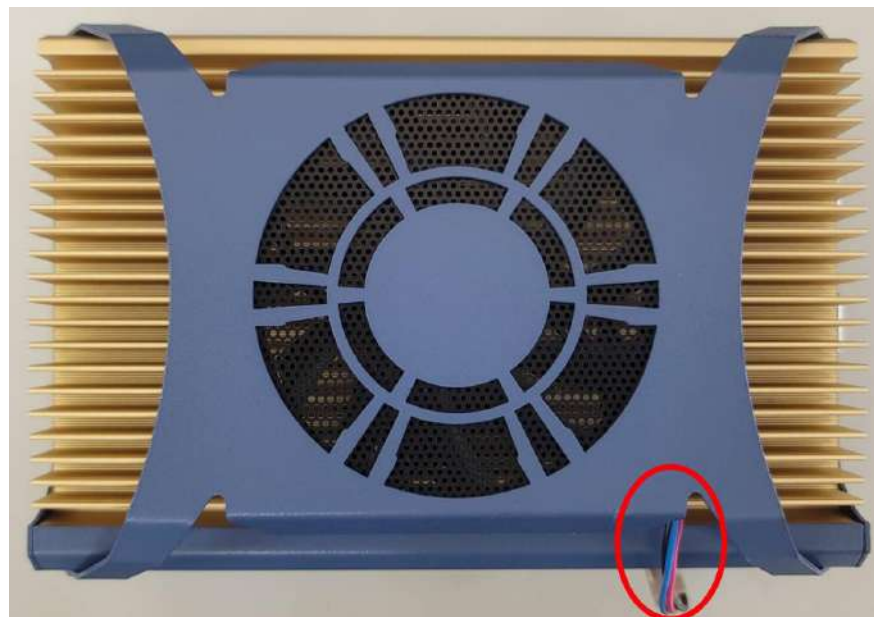

Orientation of fan's power cable must face the rear panel

2. Remove the punch-out panel, insert and connect the power cable.

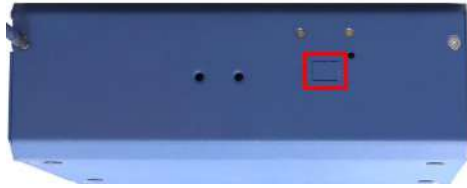

Remove the punch-out panel

Insert and connect the fan's power cable

3. Once the power cable is connected, place the supplied cable cover over the power cable and secure it with screws indicated to complete the installation.

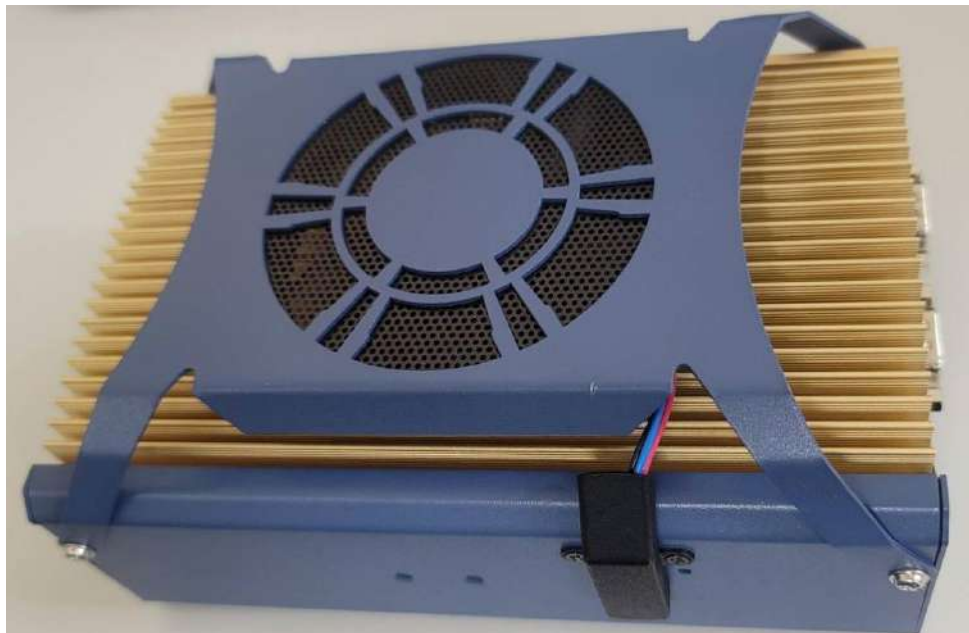
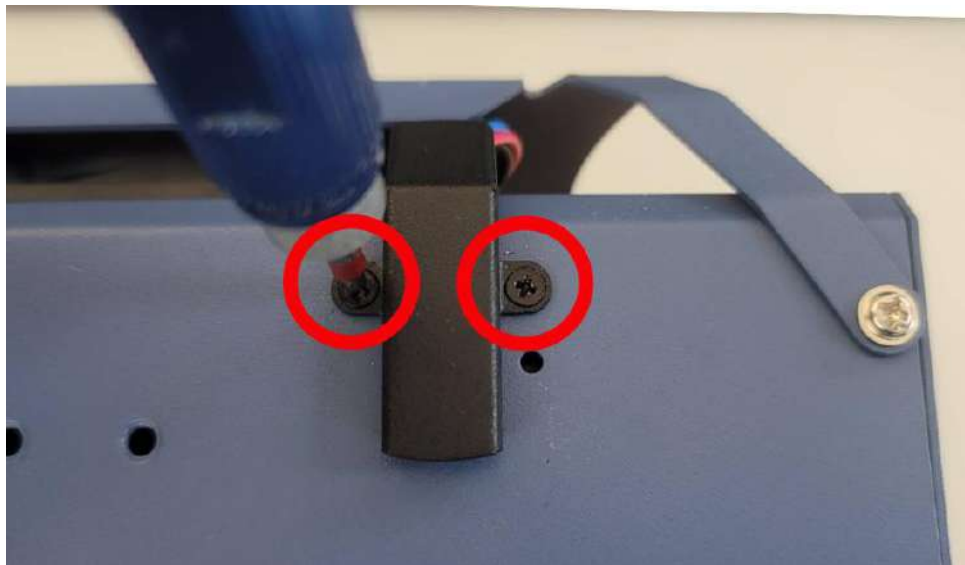

3.8 Powering On the System

There are three methods to power on the system

- [Pressing the power button](#)
- [Via an external non-latched switch](#)
- [Sending a LAN packet via Ethernet \(Wake-on-LAN\)](#)

3.8.1 Powering On Using the Power Button

This is the simplest way to turn on your system. The power button on the side panel is a non-latched switch and behaves as the ATX-mode on/off control. With DC power connected, pushing the power button will turn on the system and the PWR LED indicator will light up. Pushing the button when system is on will turn off the system. If your operating system supports ATX power mode (i.e. Microsoft Windows or Linux), pushing the power button while the system is in operation will result in a pre-defined system behavior, such as shutdown or hibernation.

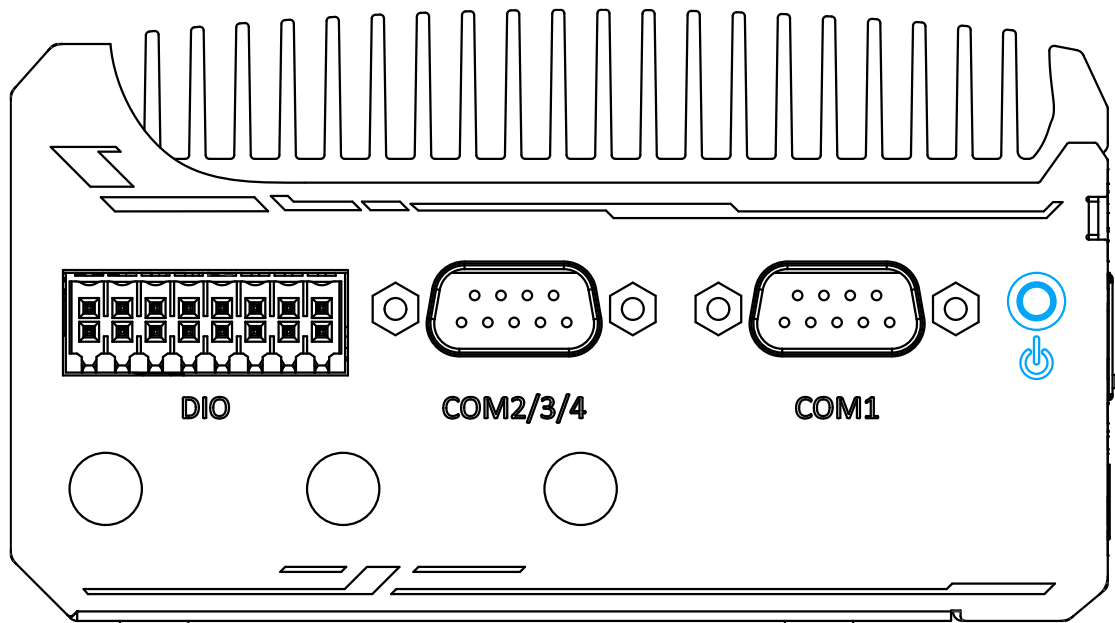

3.8.2 Powering On Using An External Non-Latched Switch

If your application demands the system to be placed inside a cabinet, you may use an external non-latched switch to power on/ off the system. The system provides a 3-pin “Remote On/ Off” plug for connecting a non-latched switch and acts as the ATX-mode power on/off control switch. The external non-latched switch acts exactly the same as the power button on the side panel. To setup and power on/ off the system using an external non-latched switch (ATX-mode), please follow the steps described below.

1. Acquire a non-latched switch with 3-pin plug.
2. Connect the non-latched switch to the Remote On/ Off plug.

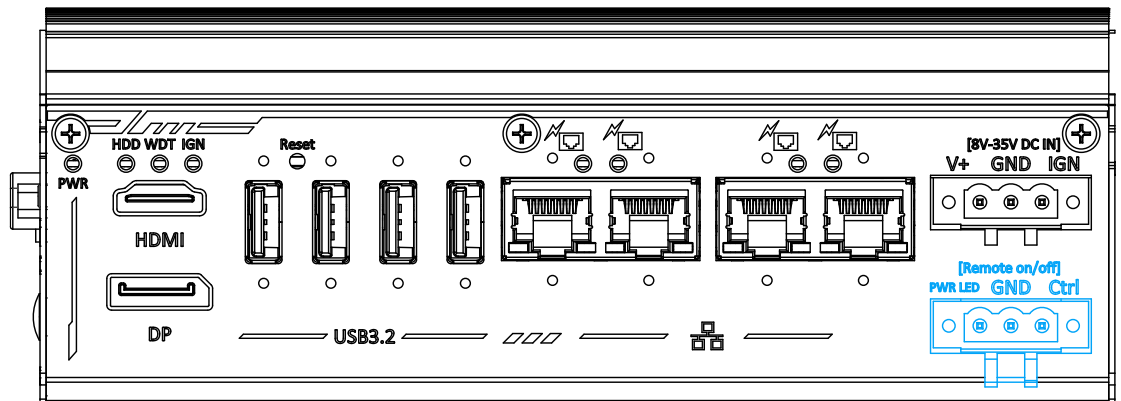

3. With DC power connected, pushing the power button will turn on the system and the PWR LED indicator will light up. Pushing the button when system is on will turn off the system. If your operating system supports ATX power mode (i.e. Microsoft Windows or Linux), pushing the power button while the system is in operation will result in a pre-defined system behavior, such as shutdown or hibernation.

3.8.3 Powering On Using Wake-on-LAN

Wake-on-LAN (WOL) is a mechanism to wake up a computer system from a S3 (standby), S4 (Hibernate) or S5 (system off with standby power) state via issuing Subnet Directed Broadcasts (SDB) or a magic packet. The system implements the Wake-on-LAN function for the GbE ports highlighted in blue, shown below.

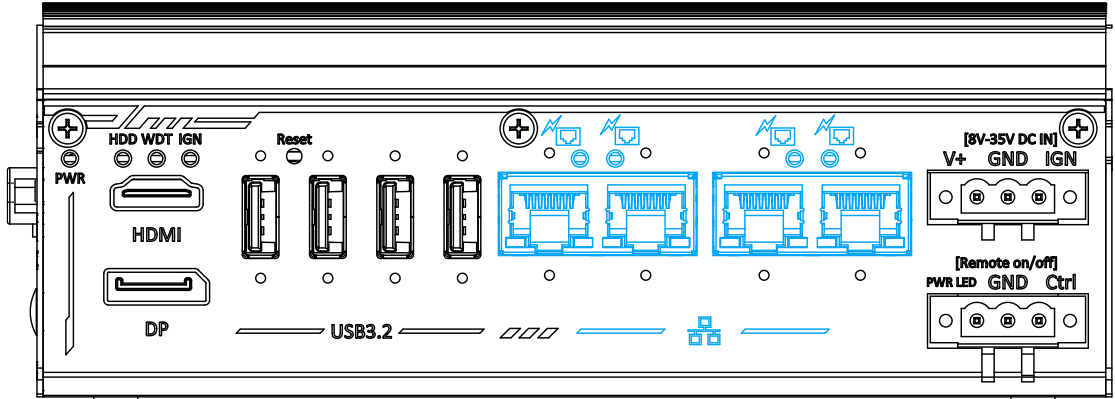

To enable WOL function and power on your system, please follow the steps below.

1. Press F2 when the system boots up to enter BIOS.
2. Enter the **[Power]** menu. And configure the **[Wake On LAN]** option as **[Enabled]**. Please refer to the [Wake-on-LAN](#) section.
3. In Windows systems, identify the Local Area Connection of the corresponding Gigabit Controller and click the **Configure** button.

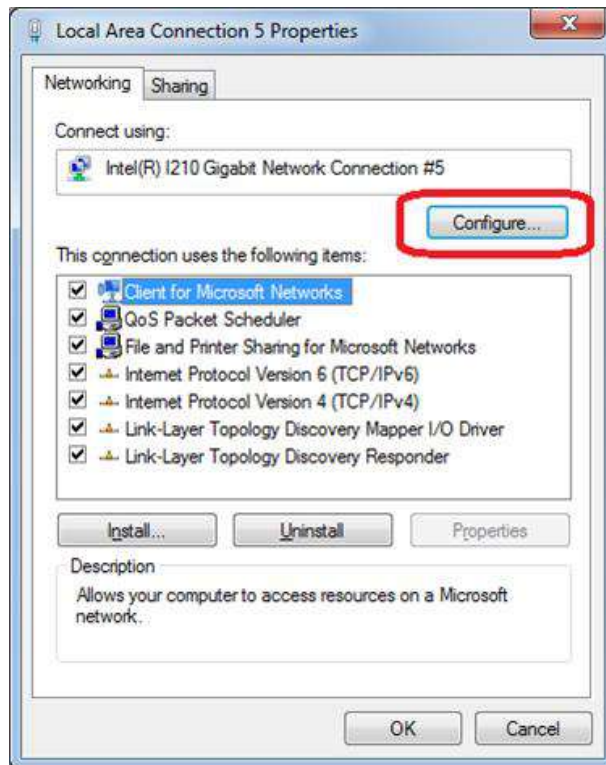

4. Click the **Power Management** tag, and check the following two options accordingly

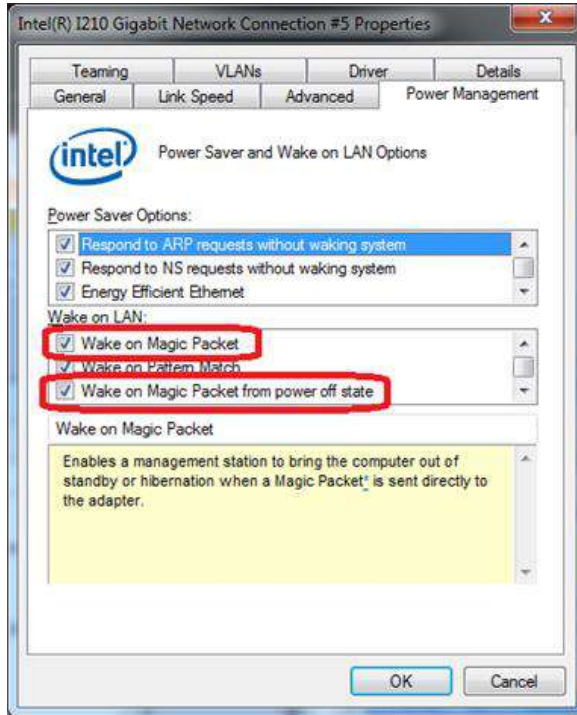

- **Wake on Magic Packet**

The system can wake from S3 or S4 state when receiving a magic packet. The magic packet is a broadcast frame containing anywhere within its payload 6 bytes of all 255 (FF FF FF FF FF FF in hexadecimal), followed by sixteen repetitions of the target computer's 48-bit MAC address.

For example, NIC's 48-bit MAC Address is 78h D0h 04h 0Ah 0Bh 0Ch

DESTINATION SOURCE MISC

FF FF FF FF FF FF

78 D0 04 0A 0B 0C 78 D0 04 0A 0B 0C

78 D0 04 0A 0B 0C 78 D0 04 0A 0B 0C

78 D0 04 0A 0B 0C 78 D0 04 0A 0B 0C

78 D0 04 0A 0B 0C 78 D0 04 0A 0B 0C

78 D0 04 0A 0B 0C 78 D0 04 0A 0B 0C

78 D0 04 0A 0B 0C 78 D0 04 0A 0B 0C

78 D0 04 0A 0B 0C 78 D0 04 0A 0B 0C

78 D0 04 0A 0B 0C 78 D0 04 0A 0B 0C

MISC CRC

There are some free tools available on Internet that can be used to send a magic packet. Please refer to the following link to understand more about Magic Packet.

<http://en.wikipedia.org/wiki/Wake-on-LAN>

- **Wake on Magic Packet from power off state**

When checking this option, the system can wake from S5 (system off with standby power) state when receiving a magic packet.

4 BIOS Settings

The system is shipped with factory-default BIOS settings optimized for best performance and compatibility. In this section, we'll illustrate some BIOS settings you may need to set or change prior to operating system installation. Please always make sure you understand the effect of change before you proceed with any changes. If you are unsure of the function you are changing, it is recommended to change one setting at a time to see its effect(s).

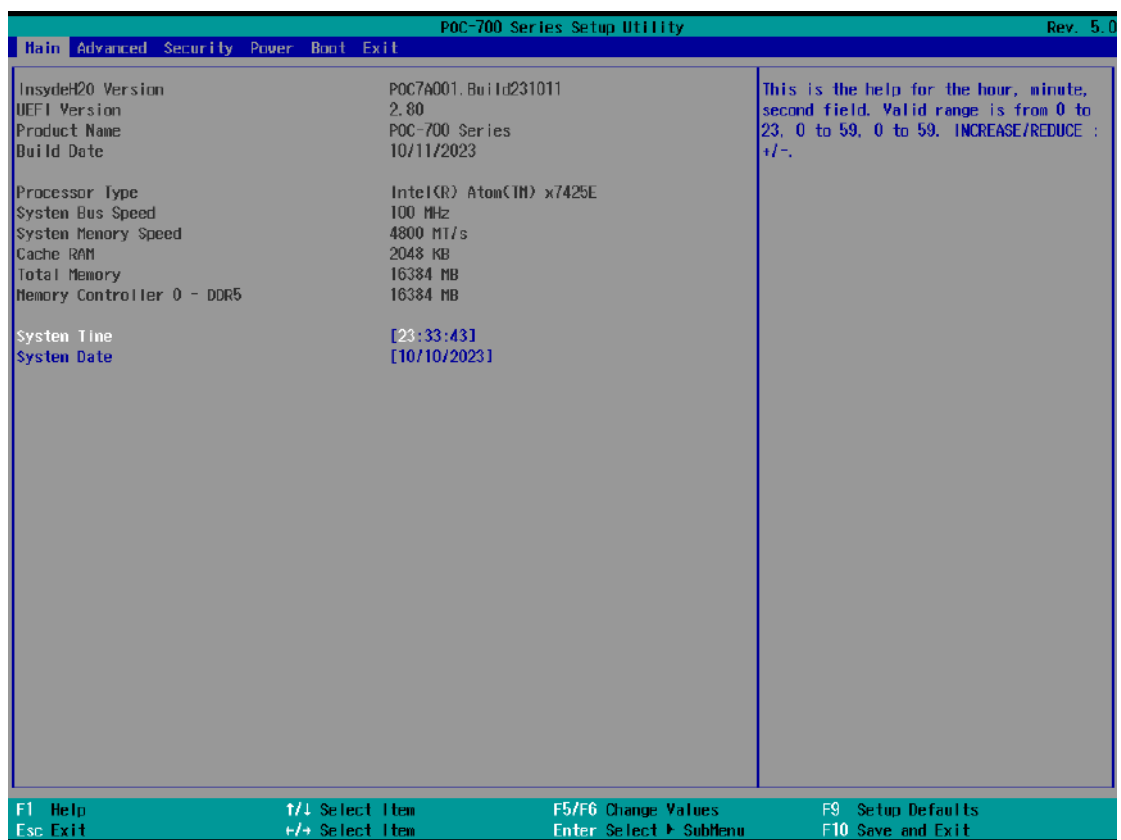

 **NOTE**

Not all BIOS settings will be discussed in this section. If a particular setting/ function you are after requires specific BIOS settings but is not discussed in this section, please contact Neousys Technical Support staff.

4.1 COM1 Port Configuration

The system's COM1 port support RS-232 (full-duplex), RS-422 (full-duplex) and RS-485 (half-duplex) mode. You can set the COM1 operating mode via BIOS settings. The option in the BIOS setting called "Slew Rate" defines how sharp the rising/falling edge is for the output signal of COM1. For long-distance RS-422/485 transmission, you may set the "Slew Rate" option as "High" to improve signal quality. For RS-422/485 communication, the "RS-422/485 Termination" option determines whether to enable/disable internal termination of RS-422/485 transceiver according to your wiring configuration (e.g. with or without external termination).

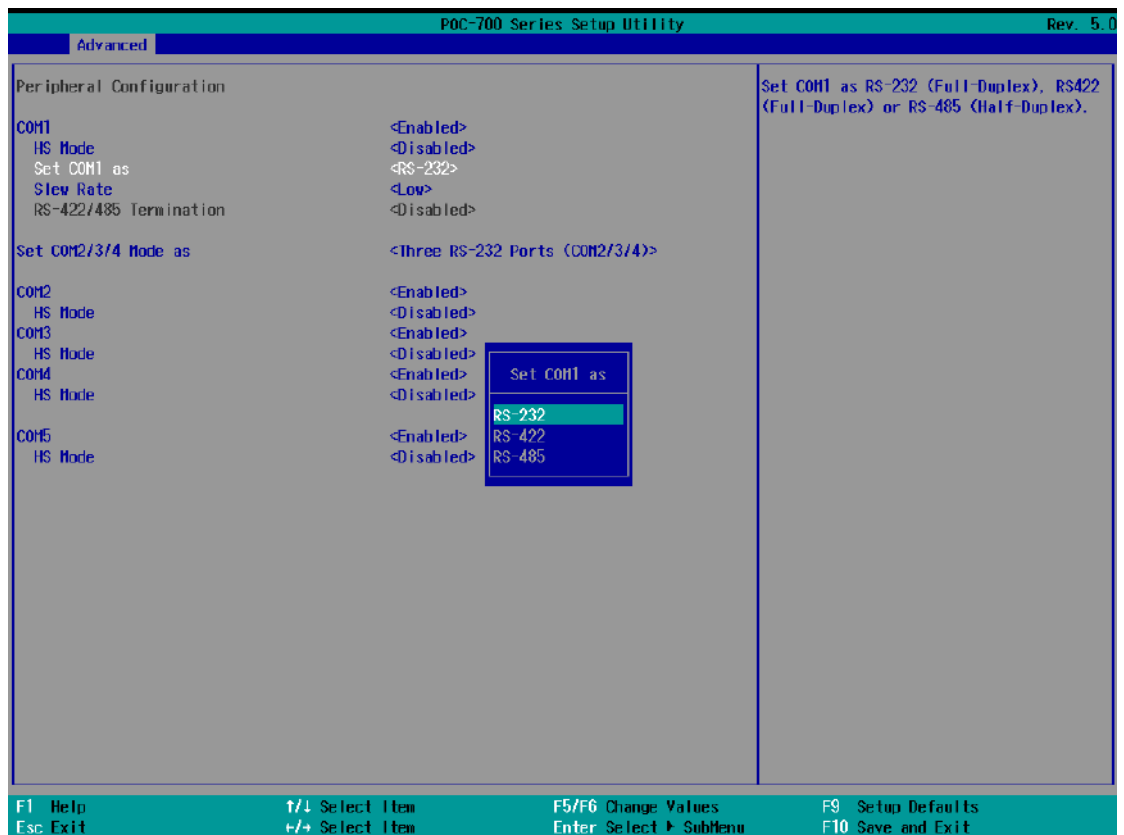

To set COM1 operating mode:

1. Press **F2** when the system boots up to enter the BIOS setup utility.
2. Go to **[Advanced] → [Peripheral Configuration]**.
3. Set the **[Set COM1 Mode as]** option to the desired mode.
4. Once set, press **F10** to save setting and exit.

4.2 COM 2/ 3/ 4 Port Configuration

The system's COM 2/ 3/ 4 ports support RS-232 (full-duplex). When set to RS-422/485 mode, it will only act as COM2 port only.

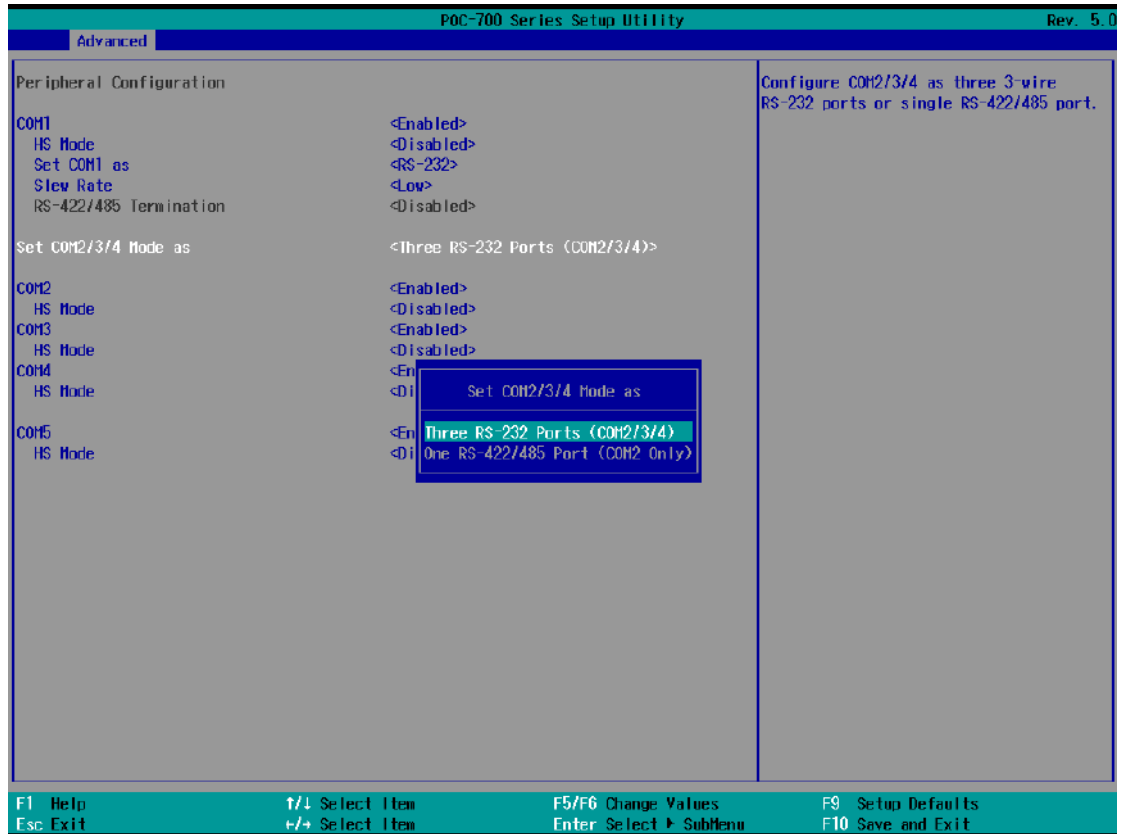

To enable COM/ 3/ 4 operating mode:

1. Press **F2** when the system boots up to enter the BIOS setup utility.
2. Go to **[Advanced]** → **[Peripheral Configuration]**.
3. Highlight the COM port (3 or 4) and set it to <Enabled> .
4. Once set, press **F10** to save setting and exit.

4.3 COM Port High Speed Mode

The high speed mode of each COM port effectively allows for the port's baud rate generator to operate at 8x the speed with an effective baud rate of 921,600 bps (115,200 x 8). Please refer to the following instructions on how to enable the high speed mode for your COM port (COM1 used as an example).



To set COM port high speed mode:

1. Press **F2** when the system boots up to enter the BIOS setup utility.
2. Go to **[Advanced] > [Peripheral Configuration]**.
3. Enable or set the **[Set COM1 Mode as]** option to the desired mode.
4. Highlight **[HS Mode]** and press ENTER to bring up options, highlight **[Enable]** and press ENTER.
5. Once set, press **F10** to save setting and exit.

4.4 TPM Availability

Trusted Platform Module (TPM) is a hardware-based cryptoprocessor to secure hardware by integrating cryptographic keys into devices. The system is designed with on-board TPM 2.0 module. It is enabled in the BIOS by default.



To enable TPM availability:

1. When system boots up, press F2 to enter BIOS setup utility.
2. Go to **[Security] > [TPM Availability]**, press ENTER to bring up Options, Available/ Hidden.
3. Highlight your selection, press Enter and press F10 to "Exit Saving Changes".

4.5 Power over Ethernet (PoE)

The Power over Ethernet (PoE) setting in the BIOS allows you to enable/ disable the PoE function of the designated port upon system boot up.

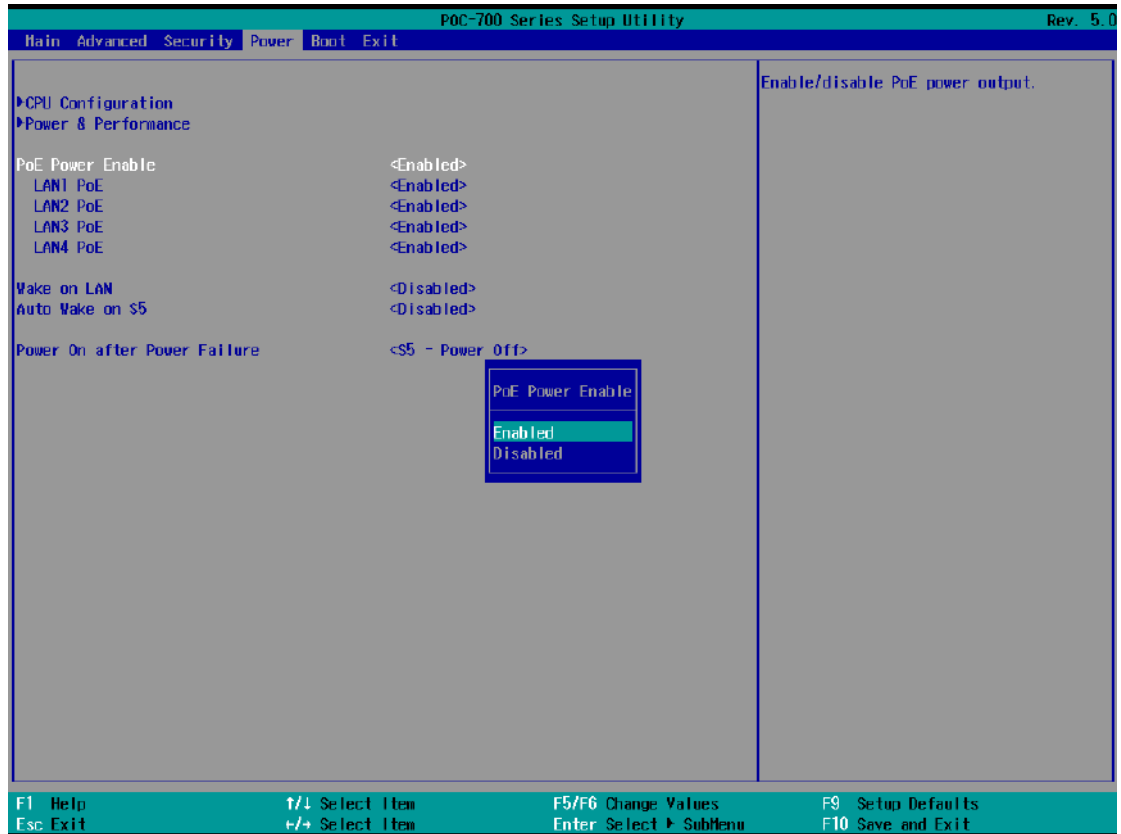

To enable/ disable Power over Ethernet settings:

1. Press **F2** when the system boots up to enter the BIOS setup utility.
2. Go to **[Power]** → **[PoE Enable]**
3. Use the up/ down arrow to highlight and select between Enabled/ Disabled, press Enter to make your selection.
4. When Enabled, you may set each LAN port's PoE function by selecting Enabled/ Disabled using the arrow key, press Enter to make your selection.

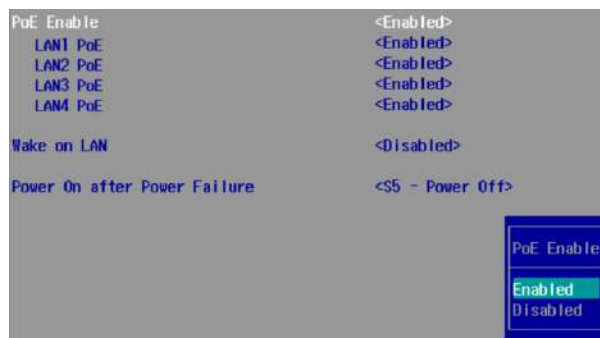

Enable/ Disable LAN PoE function

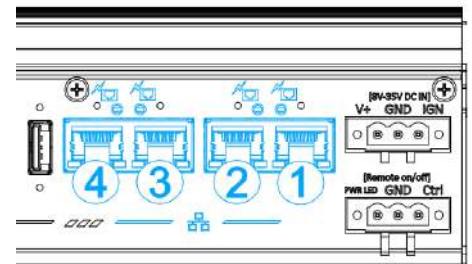

Corresponding LAN ports

5. Once set, press F10 to save setting and exit.

4.6 Wake-on-LAN

Wake-on-LAN (WOL) is a mechanism which allows you to turn on your system via Ethernet connection. To utilize Wake-on-LAN function, you have to enable this option first in BIOS settings. Please refer to Powering on via Wake-on-LAN function.



To enable/ disable “Wake on LAN” option:

1. Press **F2** when the system boots up to enter the BIOS setup utility.
2. Go to **[Power]**.
3. You may enable/disable the **[Wake on LAN]** option.
4. Once set, press **F10** to save setting and exit.

4.7 C-States

Intel processors utilize C-States to regulate the power-draw and operating frequency of each core. By enabling this function, it allows BIOS to reduce the operating frequency, power-draw, or both of the idle processor core for the system to operate more efficiently. Please refer to the steps below to enable processor C-States.

To set “Power On after Power Failure” option:

1. Press **F2** when the system boots up to enter the BIOS setup utility.
2. Go to **[Power] > [Power & Performance]** and press **ENTER**.

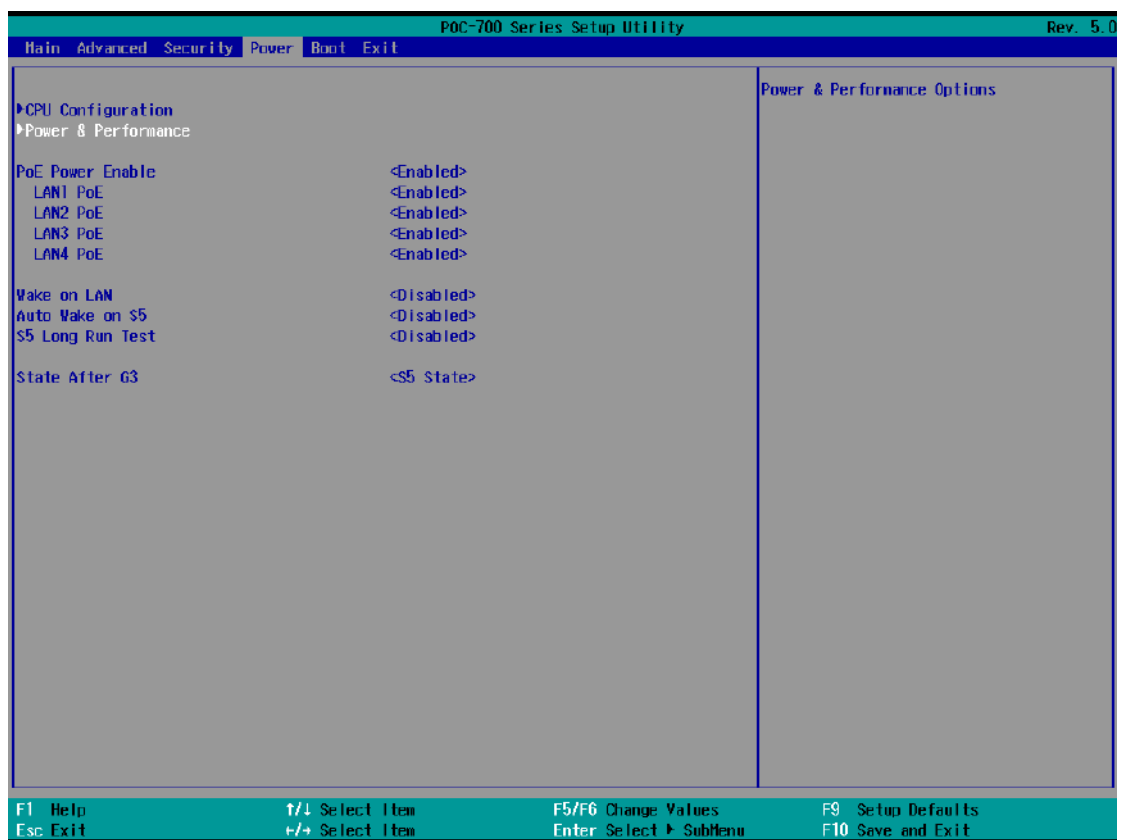

3. Highlight **"C states"** and press ENTER, set to **"Enabled"** and press ENTER.
4. Press F10 to **"Save and Exit"**.

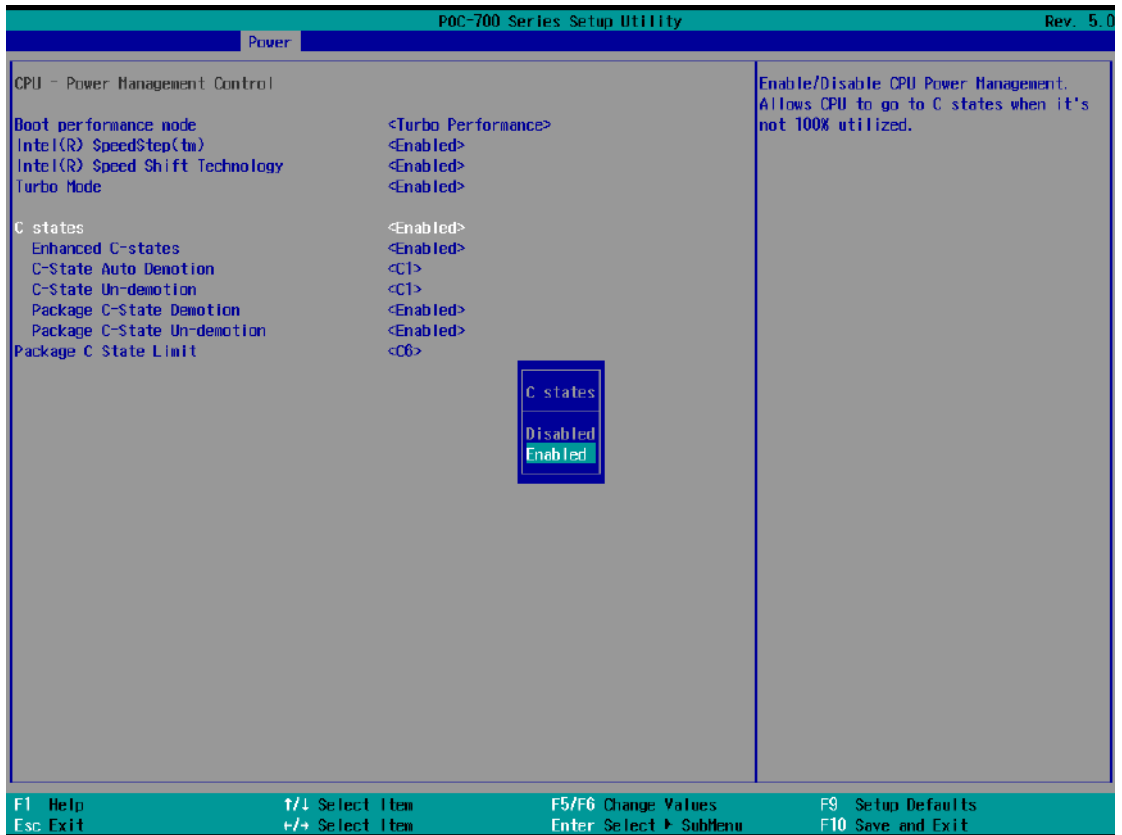

4.8 Power On after Power Failure

This option defines the system's behavior when DC power is supplied.

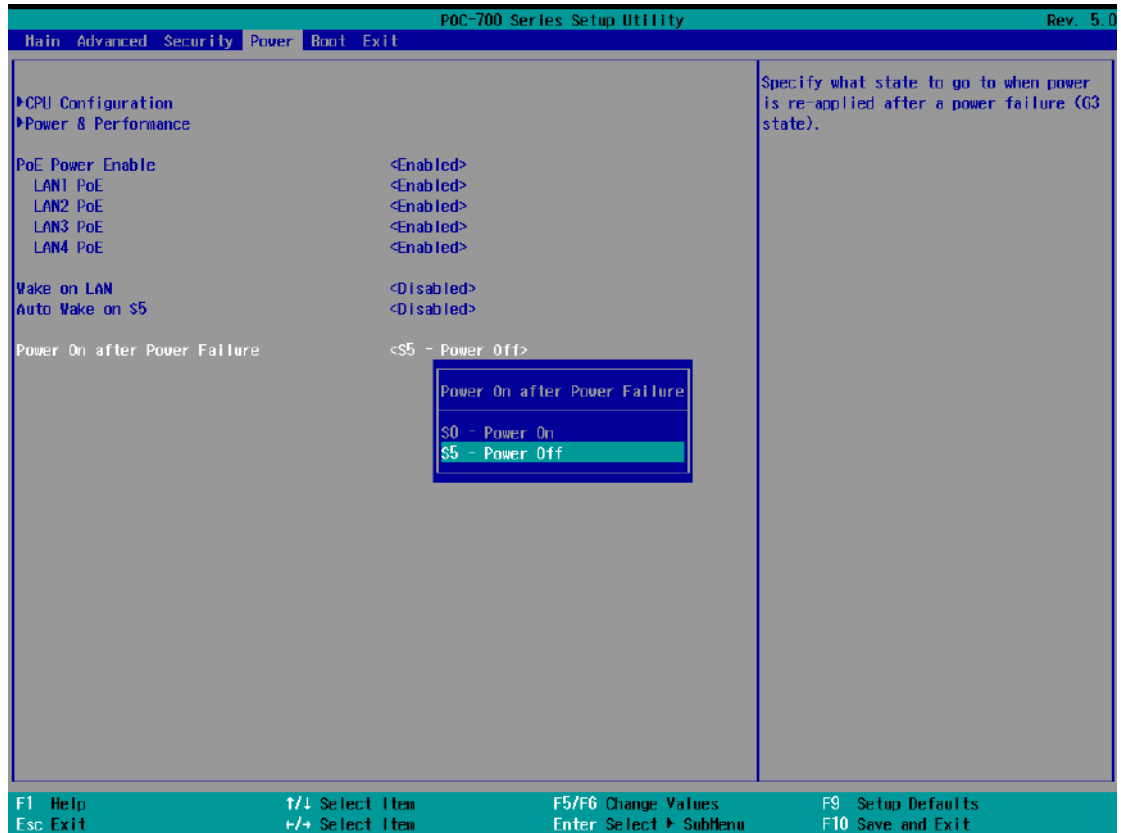

Value	Description
S0 – Power On	System is powered on when DC power is supplied.
S5 – Power Off	System is kept in off state when DC power is supplied.

When you want to use the AT-mode remote on/ off control function, you have to set this option to “S0 – Power On”. Please refer to the section [“Powering on the System”](#) for instructions of using AT-mode remote on/off control function.

To set “Power On after Power Failure” option:

5. Press **F2** when the system boots up to enter the BIOS setup utility.
6. Go to **[Power]**.
7. Set the **[Power On after Power Failure]** option to the desired setting.
8. Once set, press **F10** to save setting and exit.

4.9 Boot Menu

The Boot menu in BIOS allows you to specify the system’s boot characteristics by setting bootable device components (boot media) and method. Or, you may press F12 upon system start up and select a device you wish boot from.

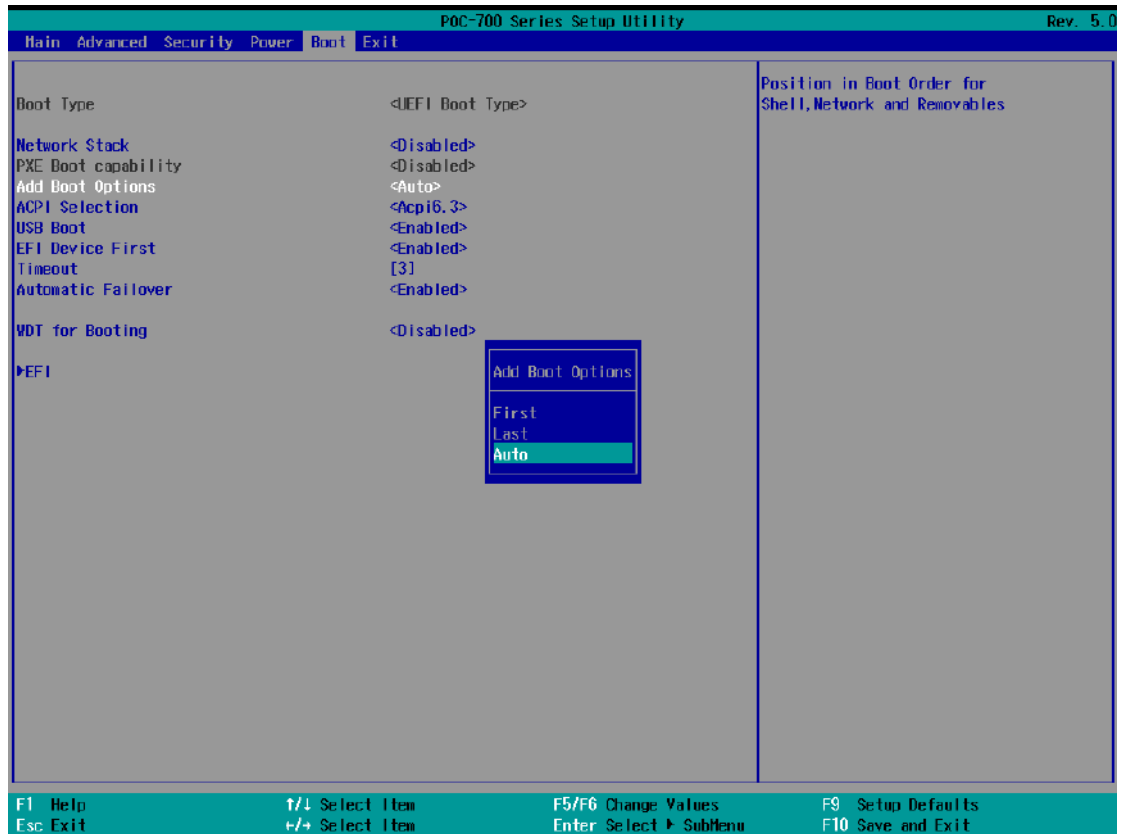

Value	Option	Description
Boot Type	UEFI Boot Type	Only UEFI boot media listed are approved as boot media.
Quick Boot	Enabled	The system starts up faster because BIOS skips various hardware function tests
	Disabled	The system starts up slower because BIOS goes through various hardware functions tests
Network Stack	Enabled	The system is available for network access using UEFI.
	Disabled	The system is not available for network access using UEFI.
PXE Boot capability	Enabled	By enabling this function, it allows the computer to load an operating system over a network connection.
	Disabled	

Add Boot Options	First	Newly detected boot media are placed at the top of the boot order.
	Last	Newly detected boot media are placed at the bottom of the boot order.
	Auto	Newly detected boot media order will be automatically detected and placed in boot order.
ACPI Selection	4.0/ 5.0/ 6.0/ 6.1/ 6.3	Advanced Configuration and Power Interface allows the operating system to control system power management
USB Boot	Enabled	Allow boot from bootable USB devices.
	Disabled	Does not allow boot from bootable USB devices
EFI Device First	Enabled	Set to boot bootable EFI media first.
	Disabled	Will not boot bootable EFI media first.
Timeout	1, 2, 3, etc (in seconds)	Boot delay time in seconds to give the user time to activate the hotkey to access the BIOS
Automatic Failover	Enabled	Automatically checks for the next bootable device when the set default device fails.
	Disabled	Will only boot from the designated device.
WDT for booting	Disabled, 1, 3, 5, 10 (minutes)	WDT ensures a successful system boot by specifying a timeout value

4.10 Position New Boot Device

The “Add Boot Options” allow you to determine whether a newly added device (eg. USB flash disk) is to boot as the first device to boot or the last in the boot sequence.

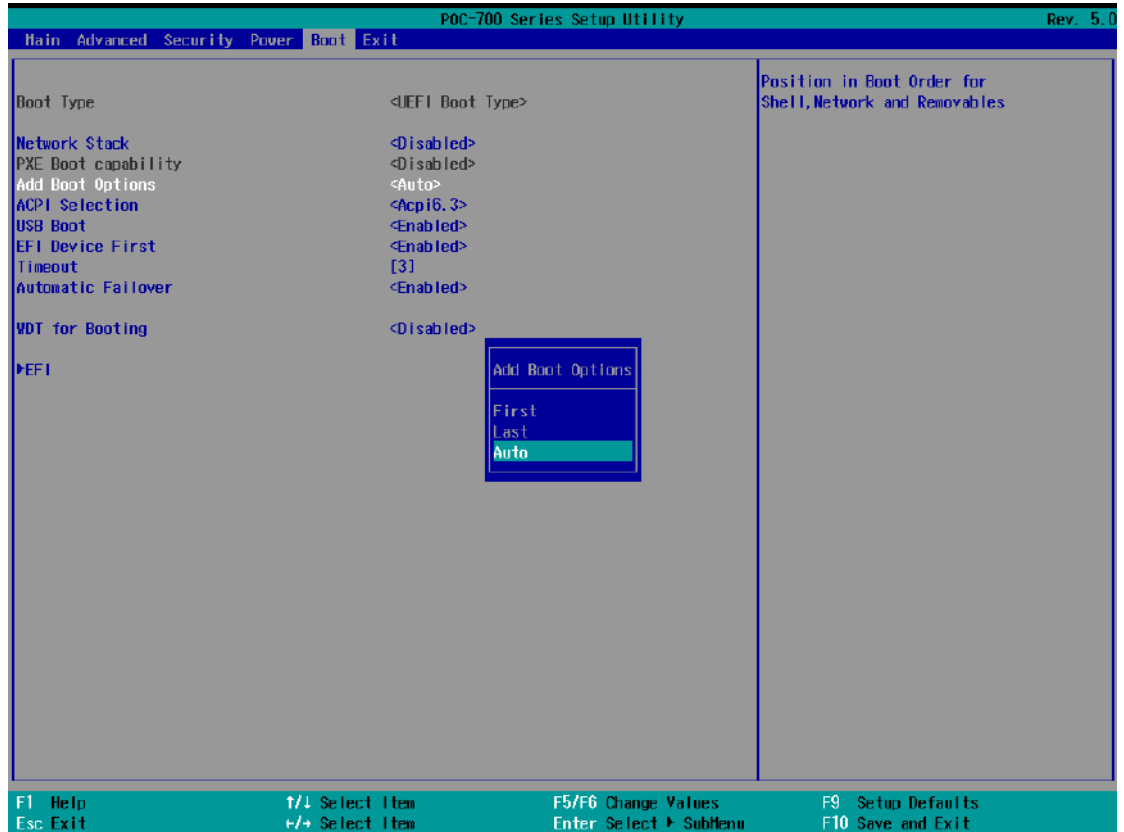

To set the newly-installed boot device as the first or last boot device:

1. Press **F2** when the system boots up to enter the BIOS setup utility.
2. Go to **[Boot] > [Add Boot Options]** menu.
3. Select **[First]** or **[Last]** for your newly-added boot device and press Enter.
4. Once set, press **F10** to save setting and exit.

4.11 Watchdog Timer

The watchdog timer secures the boot process by means of a timer. Once the timer expires, a reset command is issued to initiate another booting process. There are two options in BIOS menu, “*Automatically after POST*” and “*Manually after Entering OS*”. When “*Automatically after POST*” is selected, the BIOS automatically stops the watchdog timer after POST (Power-On Self Test) OK. When “*Manually after Entering OS*” is selected, the user must stop the watchdog timer once booted into the OS. This guarantees the system can always boot into the OS, otherwise another booting process will be initiated. For information about programming watchdog timer, please refer to [Appendix A Using WDT & DIO](#).

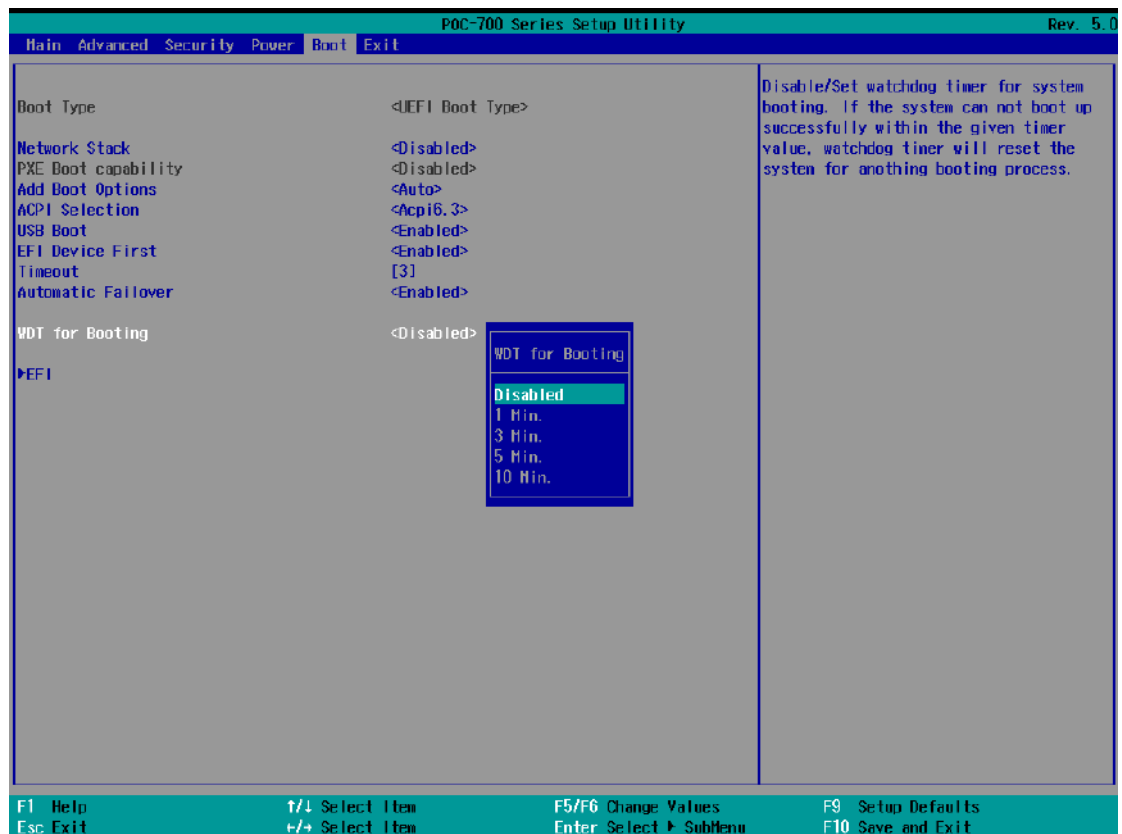

To set the watchdog timer for boot in BIOS:

1. Press **F2** when the system boots up to enter the BIOS setup utility.
2. Go to **[Boot]** menu.
3. Disable or select timeout value for **[WDT for Booting]** option.
4. Once you set a timeout value, the **[WDT Stop Option]** option appears. You can select either “*Automatically after POST*” or “*Manually after Entering OS*”.
5. Once set, press **F10** to save setting and exit.

5 OS Support and Driver Installation

5.1 Operating System Compatibility

The system supports most operating system developed for Intel® x86 architecture. The following list contains the operating systems which have been tested by Neosys Technology.

- Microsoft Window 10 LTSC 2021 (x64)
- Microsoft Windows 11 IoT Enterprise 22H2 64-bit
- Ubuntu 20.04.2 LTS or other distribution with kernel version ≥ 5.19 */**



NOTE

For other Linux OS, Linux kernel should upgrade to 5.19

**For Linux system, user may need to manually compile and install the driver for Intel graphics or Ethernet controller if the driver is not embedded in kernel. You can visit Intel website for further information.*

***For distributions, graphics driver may not be completely implemented in its kernel. You may encounter restrictions when using these features, such as multiple independent displays. For optimum operation, it is the users' responsibility to manually check for new drivers and upgrades!*

Neosys may remove or update operating system compatibility without prior notice. Please contact us if your operating system of choice is not on the list.

5.2 Driver Installation

The system drivers are available online, please click on this [link](#) to download the drivers.

5.3 Driver Installation for Watchdog Time Control

Neosys provides a driver package which contain function APIs for Watchdog Timer control function. You should install the driver package (WDT_DIO_Setup.exe) in prior to use these functions. Please download the latest version of WDT_DIO_Setup.exe to ensure compatibility.

Please refer to this [link](#) to download WDT_DIO.

Appendix A Using WDT & DIO

The watchdog timer (WDT) function ensures reliable system operation. The WDT is a hardware mechanism to reset the system if the watchdog timer is expired. Users can start the WDT and keeping resetting the timer to make sure the system or program is running. Otherwise, the system shall be reset.

In this section, we'll illustrate how to use the function library provided by Neosys to program the WDT functions. Currently, WDT driver library supports Windows 10 x64 and WOW64 platform. For other OS support, please contact Neosys Technology for further information.

Installing WDT_DIO Library

The WDT_DIO function library is delivered in the form of a setup package named **WDT_DIO_Setup.exe**. In prior to program WDT, you should execute the setup program and install the WDT library. Please use the following WDT_DIO_Setup packages according to your operating systems and application.



NOTE

Please download from Neosys website and install the latest WDT_DIO_Setup.exe file.

WDT and DIO Library Installation

WDT_DIO_Setup.2.4.0.0.exe will be used as an example to demonstrate WDT & DIO Library installation setup process. Please refer to the instructions below.

1. Execute **WDT_DIO_Setup.2.4.0.0.exe**.

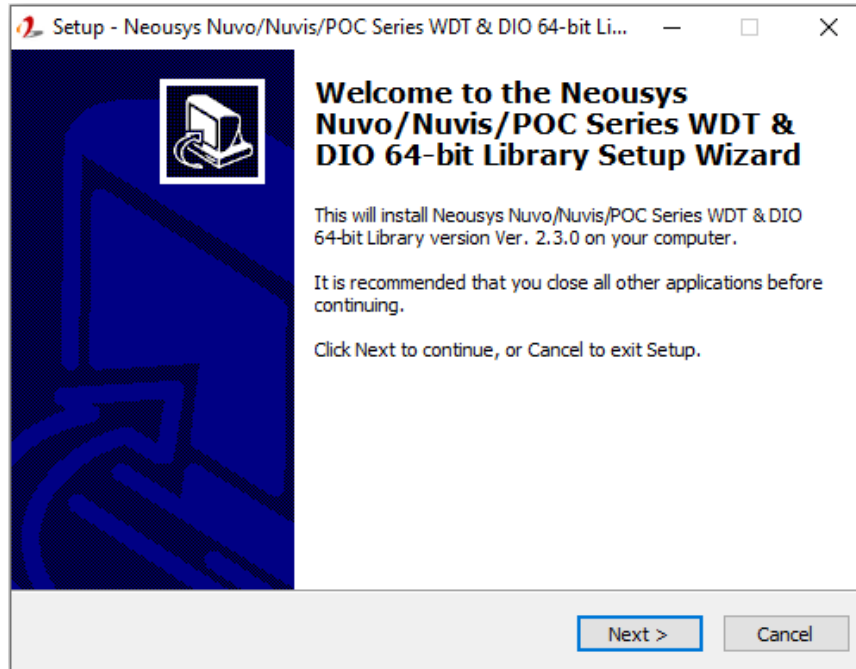

2. Click "Next >" and specify the directory of installing related files. The default directory is *C:\Neosys\WDT_DIO*.

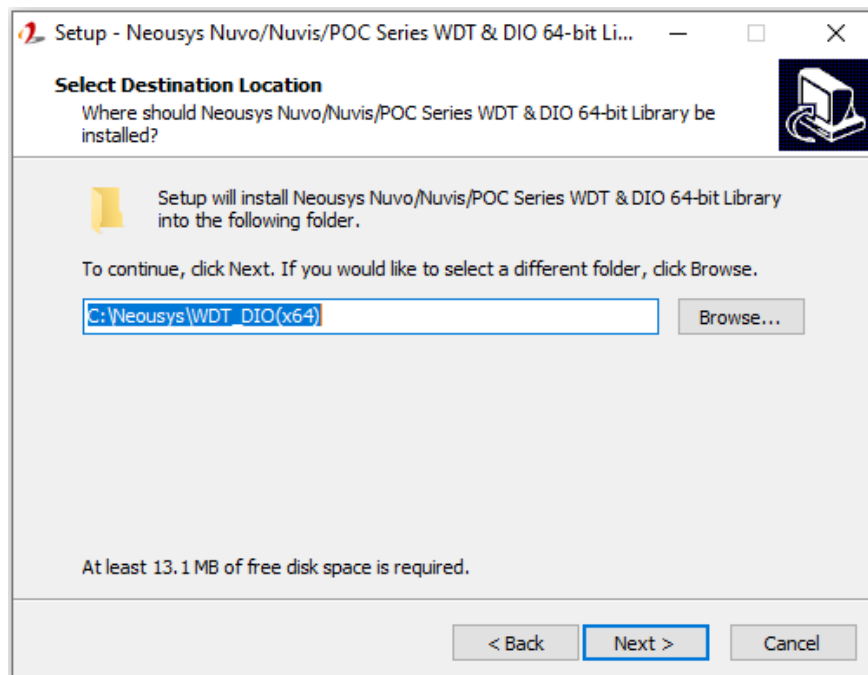

- Once the installation has finished, a dialog will appear to prompt you to reboot the system. The WDT & DIO library will take effect after the system has rebooted.

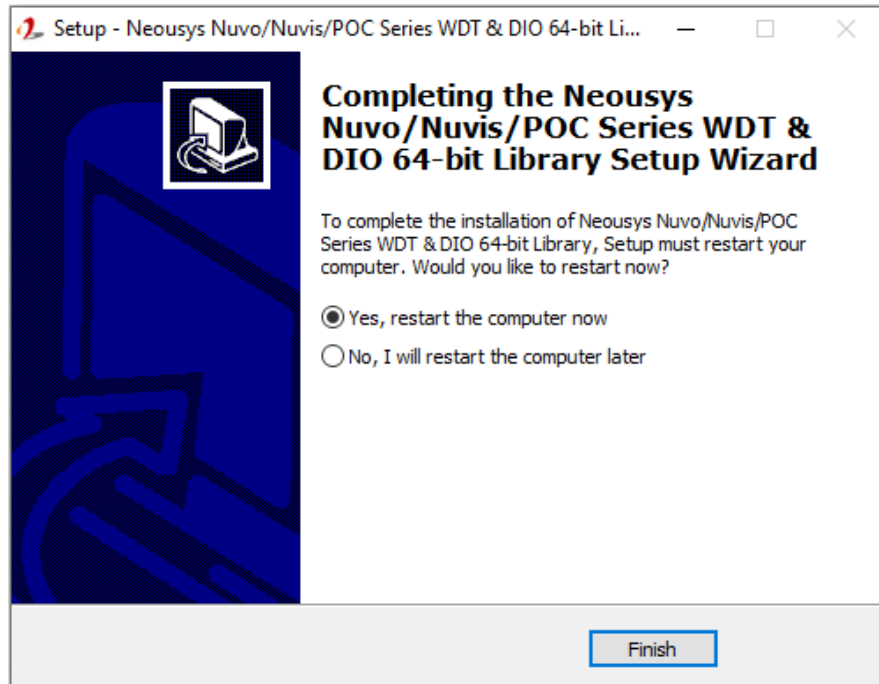

- When programming your WDT or DIO program, the related files are located in

Header File:	\Include
Library File:	\Lib
Function Reference:	\Manual
Sample Code:	\Sample\WDT_Demo (Demo for Watchdog Timer) \Sample\DIO_Demo (Demo for isolated DIO Control) \Sample\COS_Demo (Demo for change-of-state DI)

WDT Function Reference

InitWDT

Syntax	BOOL InitWDT(void);
Description:	Initialize the WDT function. You should always invoke InitWDT() before set or start watchdog timer.
Parameter	None
Return Value	TRUE: Successfully initialized FALSE: Failed to initialize
Usage	BOOL bRet = InitWDT();

SetWDT

Syntax	BOOL SetWDT(WORD tick, BYTE unit);
Description	Set timeout value and unit for watchdog timer. When InitWDT() is invoked, a default timeout value of 255 seconds is assigned.
Parameter	<i>tick</i> WORD value (1 ~ 65535) to indicate timeout ticks. <i>unit</i> BYTE value (0 or 1) to indicate unit of timeout ticks. 0 : unit is minute 1: unit is second
Return Value	If value of unit is correct (0 or 1), this function returns TRUE, otherwise FALSE.
Usage	WORD tick=255; BYTE unit=1; //unit is second. BOOL bRet = SetWDT(tick, unit); //timeout value is 255 seconds

StartWDT

Syntax	BOOL StartWDT(void);
Description	Starts WDT countdown. Once started, the WDT LED indicator will begin blinking. If ResetWDT() or StopWDT is not invoked before WDT countdowns to 0, the WDT expires and the system resets.
Parameter	None
Return Value	If the timeout value is given in correct format (WDT started), this function returns TRUE, otherwise FALSE
Usage	BOOL bRet = StartWDT()

ResetWDT

Syntax	BOOL ResetWDT(void);
Description	Reset the timeout value to the value given by SetWDT().If ResetWDT() or StopWDT is not invoked before WDT countdowns to 0, the WDT expires and the system resets.
Parameter	None
Return Value	Always returns TRUE
Usage	BOOL bRet = ResetWDT()

StopWDT

Syntax	BOOL StopWDT(void);
Description	Stops the countdown of WDT. When WDT has stopped, the WDT LED indicator stops blinking.
Parameter	None
Return Value	Always returns TRUE
Usage	BOOL bRet = StopWDT()

DIO Functions

InitDIO

Syntax	BOOL InitDIO(void);
Description	Initialize the DIO function. You should always invoke InitDIO() before write/read any DIO port/channel.
Parameter	None
Return Value	Returns TRUE if initialization successes, FALSE if initialization failed.
Usage	BOOL bRet = InitWDT();

DIReadLine

Syntax	BOOL DIReadLine(BYTE ch);
Description	Read a single channel of isolated digital input.
Parameter	ch BYTE value specifies the DI channel to be read. <i>Ch</i> should be a value of 0 ~ 7.
Return Value	The status (TRUE or FALSE) of the specified DI channel.
Usage	BYTE ch=3; //DI channel #3 BOOL DIChValue = DIReadLine(ch); //read DI channel #3

DIReadPort

Syntax	WORD DIReadPort(void);
Description	Read the entire isolated digital input port (8 channels).
Parameter	None
Return Value	A WORD value (0~255) indicates the status of DI port (8 DI channels).
Usage	WORD DIPortValue = DIReadPort ();

DOWriteLine

Syntax	void DOWriteLine(BYTE ch, BOOL value);
Description	Write a single channel of isolated digital output.
Parameter	<p>ch BYTE value specifies the DO channel to be written. <i>Ch</i> should be a value of 0 ~ 7.</p> <p>value BOOL value (TRUE or FALSE) specifies the status of DO channel.</p>
Return Value	None
Usage	<pre> BYTE ch=3; //DI channel #3 BOOL DOChValue=TRUE; DOWriteLine(ch, DOChValue); //write DO channel #3 as TRUE </pre>

DOWritePort

Syntax	void DOWritePort(WORD value);
Description	Write the entire isolated digital output port (8 channels).
Parameter	<p>value WORD value specifies the status of the DO port. <i>Value</i> should be a value of 0~255.</p>
Return Value	None
Usage	<pre> WORD DOPortValue=0XFF; //11111111b DOWritePort(DOPortValue); //write DO port as 11111111b </pre>

Appendix B PoE On/ Off Control

The system offers four 802.3at PoE+ ports with a unique feature to allow users manually turn on or off the power supply of each PoE port. This can be function can be useful in power device (PD) fault-recovery or power reset.

The function APIs are encapsulated in Neousys WDT_DIO driver package. Please follow the instructions in [Appendix A Watchdog Timer & Isolated DIO](#) to install the driver package prior to programming PoE on/off control function

PoE On/ Off Control Function Reference

GetStatusPoEPort

Syntax	BYTE GetStatusPoEPort (Byte port);
Description	Get current on/off status of designated PoE port.
Parameter	<i>port</i> BYTE value specifies the index of PoE port. Please refer to the following illustration, <i>port</i> should be a value of 1 ~ 4.
Return Value	BYTE value indicating PoE on/off status 0 if port is disabled (off) 1 if port is enabled (on)
Usage	BYTE bEnabled = GetStatusPoEPort (1); //Get on/off status of PoE Port#1

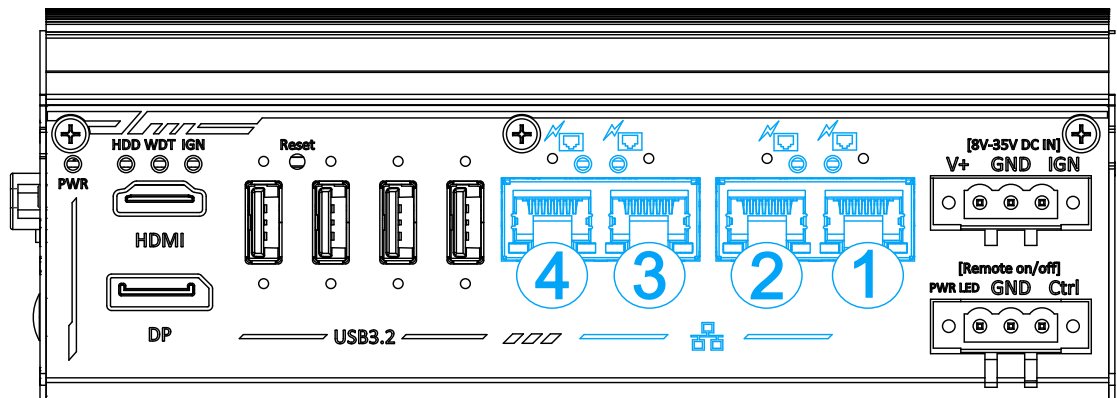

EnablePoEPort

Syntax	BOOL EnablePoEPort (BYTE port);
Description	Turn on PoE power of designated PoE port.
Parameter	<i>port</i> BYTE value specifies the index of PoE port. Please refer to the following illustration, <i>port</i> should be a value of 1 ~ 4
Return Value	TRUE if enabled success FALSE if fail to enable.
Usage	BOOL bRet = EnablePoEPort (1); //Turn on PoE Port#1

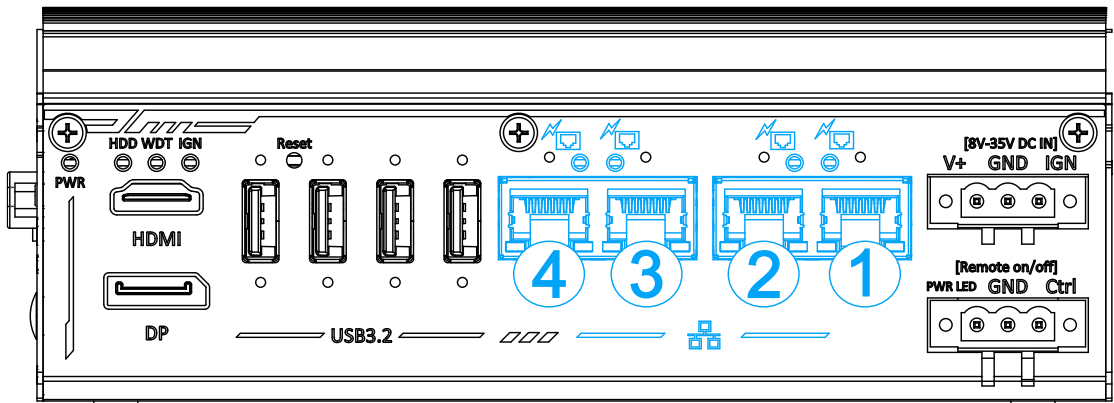

DisablePoEPort

Syntax	BOOL DisablePoEPort (BYTE port);
Description	Turn off PoE power of designated PoE port
Parameter	<i>port</i> BYTE value specifies the index of PoE port. Please refer to the following illustration, <i>port</i> should be a value of 1 ~ 4
Return Value	TRUE if disabled success FALSE if fail to disable
Usage	BOOL bRet = DisablePoEPort (1); //Turn off PoE Port#1

